

# Reduction of Power Quality Issues in micro-grid using GA Tuned PI Controller Based DVR

<sup>1</sup>Thaha.H.S, <sup>2</sup>Dr.T.Ruban Deva Prakash

## Abstract

In the present energy scenario, one of major problems is with Power quality. Power quality came to more relevant, focused, with the addition of suitable equipment, where its behavior is very much important to the power supply quality. Power quality issue is a phenomenon noted as a not usual standard current, frequency or voltage which may results in a failure of sophisticated devices. The main issue focuses at the power swell & sag. In the paper, authors present a novel methodology for the prevention of voltage sag & swell. To rectify this issue, customized power equipments are adopted. Among them, Dynamic Voltage Restorer (DVR), the best as well as right advanced customized power equipment used in power distribution networks. The advantages include reduced price, low size, and its good transient response to the interferences. This work explain the MATLAB results of a Dynamic Voltage Restorer (DVR) modeling and analysis. Here, conventional controller like PI type and GA Tuned PI controller are used for comparison. In the proposed method, GA Tuned PI controller implemented are replaced by the conventional PI controller to develop the performance of the plant. The aim of the controller is made faster than conventional technique based controller. By MATLAB simulation tool, the performance can be studied.

**Keywords:** DVR, Genetic Algorithm, Solid State Devices, Power Quality

## I. Introduction

At present, latest industrial equipment is normally operating on power electronic devices like alterable speed driver circuits & programmable logic controllers. The electronic type equipments are mainly responsible to interferences which may have not so much tolerable to power quality issues like voltage swells, harmonics disturbances and sags. The important critical interferences to the industrial devices are voltage dips [1, 5].

DVRs usually a type of customized power equipment which will give consistent power quality in the distribution side. It utilize technology named boosting of voltage by compensations like swell or sag with the help of solid state devices [22]. Dynamic Voltage Restorer are the most commonly used in responding to slight change in loads which will be largely influenced by system voltage variations.

Different power quality issues ie. Swells, Sags, harmonics etc., in which voltage sags are the main affected critical interferences. Using the custom power devices, these problems can be rectified. The best and right advanced customized device for power enhancement is the DVR used in power distribution networks [20], which is the newly introduced cascaded type circuit in the solid state field which inserts voltages into network for controlling the voltages from load side. This is usually equipped in a distribution network intermediate at the common coupling point is the load feeder and the utility feeder.

Intelligent Controllers compared with the conventional PI Controller to enhance the system performance with the help of the DVR. The main aim of the above said one is to enhance the power quality of the network during the major variety of faults. Three phase fault is explained in this paper.

## II. Composition of DVR

Basic elements of DVR comprises the below main units as given in **Fig.1**.

<sup>1</sup>Research Scholar, Dept of EEE, Sathyabama University, Chennai. E-mail: [thahahs2017@gmail.com](mailto:thahahs2017@gmail.com)

<sup>2</sup>Principal & Professor, Department of EEE, Heera College of Engineering and Technology, Nedumangad, Kerala, India, E-mail: [mahiruban2006@yahoo.co.in](mailto:mahiruban2006@yahoo.co.in)

1. DC charging circuit
2. Injection/ Booster transformer
3. Voltage Source Converter (VSC)
4. Harmonic filter
5. Storage Devices
6. Control and Protection System

### 1. Charging of DC Circuit

Charging of dc circuit has following important jobs.

1. After a sag compensation procedure, the first step of dc charging circuit is charge the energy source.
2. To keep DC Link voltages at normal DC Link voltages, second job is done by dc charging circuit.

### 2. Injection/ Booster Transformer

To prevent the coupling of unwanted signals and temporary voltages of primary to secondary is done with Injection / Booster transformer [11, 15]. Its major functions are given below.

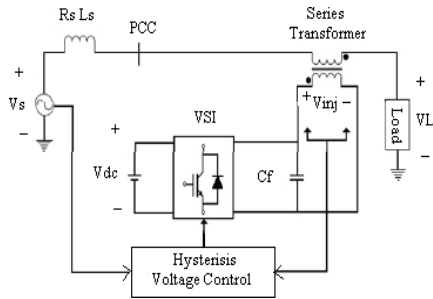


Fig. 1 Composition of DVR.

- 1) Injection / Booster transformer couples the inserted compensating voltages developed by voltage source converters to the voltage supply at the incoming side and connect the distribution system by DVR utilizing HV- winding of the transformer.
- 2) Isolation of the network load (VSC and control mechanism) is done with Injection / Booster transformer.

### 3. Voltage Source Converter (VSC)

VSC is made of power electronics elements which comprises of a storage part and switching equipment that give a sine voltages from important magnitude, phase angle and frequency,. DVR uses, the VSC is utilized to briefly replacing input voltage-

- supply or to develop a small amount of the supply voltage which is absent [21].

The important intention of the storage equipment is give essential energy to VSC using a DC Link for production of inserted voltages. Main types of energy storage equipments are capacitance and batteries [12], and also superconductive magnetic energy storage (SMES) [16, 18].

## III. DVR Formulas

Load impedances  $Z_{th}$  rely on load bus fault level. When system voltage ( $V_{th}$ ) decreases, DVR inserts a series voltage  $V_{DVR}$  to the insertion transformer hence wanted magnitude load voltage  $V_L$  can be perpetuated as shown in **Fig.2**. The inserted series voltages of the DVR in the form of

$$V_{DVR} = V_L + Z_{th} I_L - V_{th} \quad (1)$$

$V_L$ : The required voltage magnitude at the sideload

$Z_{th}$ : The impedance at the load side

$I_L$ : The current at the load side

$V_{th}$ : The system voltage at the fault situation

The current at the load side  $I_L$  is expressed as,

$$I_L = [P_L + jQ_L] / V_L \quad (2)$$

Take the reference equation as  $V_L$  which is expressed as,

$$V_{DVR} \angle \alpha = V_L \angle 0 + I_L Z_{th} \angle (\theta - \beta) - V_{th} \angle \delta \quad (3)$$

$\alpha$ ,  $\beta$ ,  $\delta$  are angles of  $V_{DVR}$ ,  $Z_{th}$ ,  $V_{th}$  respectively and  $\theta$  is load power angle.

The DVR complex power inserted can be expressed as,

$$S_{DVR} = V_{DVR} I_L^* \quad (4)$$

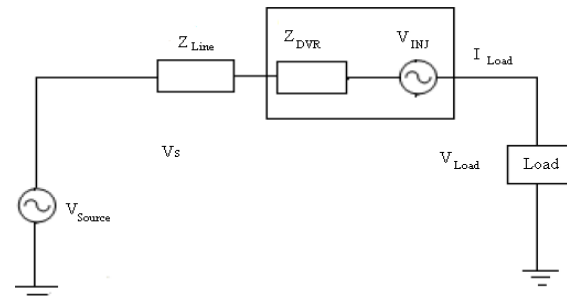


Fig. 2 DVR Equivalent Circuit.

## IV. CONTROL STRATEGIES

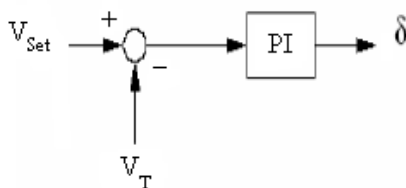
Different types of control techniques suggested for DVR are PWM based Voltage Space Vector control suggested by Changjiang Zhan et al in [13 & 14]. Nagaraj et al [6] discussed the soft computing techniques based tuning algorithms for PID controller. These reviews tell that the transient response of the GA Tuned based PI tuning is better than that of PI types of Controllers. A latest method to find symmetrical parts for DVR controlling was proposed by Mostafa I. Marei et al [19].

Use of DVR with hysteresis voltage control was suggested by H. Ezoji et al [17]. To control the DVR, unipolar pulse width modulation utilizes the Hysteresis voltage control method. Fast controllability and simple application based voltage control based on hysteresis band has the largest demand over many types of control techniques.

### 1. PI Controller

The control technique is very much important in order to limit voltage magnitude as a constant one at the point where a dedicated load is connected during system interferences. At load terminals, Root mean square (RMS) voltages are only checked by the control system, i.e., no requisite of kVAR power measurements. For simplicity and good response, the VSC switching approach deals with a sinusoidal PWM method. PWM techniques provide a better flexible alternative technique compared to the Fundamental Frequency Switching (FFS) techniques, because the custom power is comparatively a lower-power wanted one. Without affecting considerable switching losses, extortionate switching frequencies can be utilized have better efficiency of the converter,

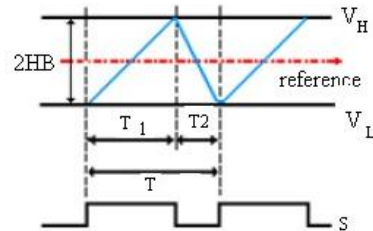
Difference in the reference voltages and RMS value at terminal voltages measured called as the error signal which is the controller input. A PI Controller, such an error is controlled, the angle at output is  $\delta$ , that is given to signal generator which is PWM as shown in **Fig.3**. By comparing reference voltages with the measured voltage (RMS) at the load side, an error signal is developed. Conventional controller type PI regulates the zero error which means that the rms load voltage is returned to voltage reference.



**Fig. 3** PI Controller.

### 2. Hysteresis Voltage Control

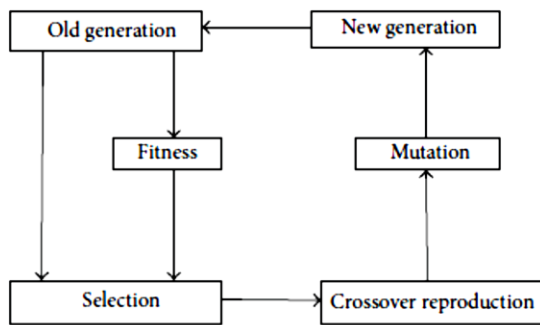
To get better voltage at the load side and divert switching signals for inverters gates, hysteresis voltage control is utilized. An error signal between an injection voltage ( $V_{inj}$ ) and a reference voltage of DVR ( $V_{ref}$ ) which develops appropriate control signals is very much needed for hysteresis voltage control [17] as shown in **Fig.4**.



**Fig. 4** Hysteresis Band Voltage Control.

### 2. Genetic Algorithm (GA)

GA are optimized forage algorithms based on evolution, natural selection and natural genetics from biological systems in a computer algorithm to replicate evolution explained by Ge et al [9] and Melanie Mitchell [8]. They correlate survival of fittest with different structures that is yet to randomize information passing to constitute a search algorithm. In the early 1960s, John Holland and his colleagues created Genetic Algorithm in the University of Michigan. To give robust search in complex phases, genetic algorithms are theoretically and empirically been proved. Its validity in –Function Optimization and Control Applications is well known. Genetic Algorithms (GA) define a general method for searching global minima or maxima in a bounded, quantized search space. GA can be generally given to approximately any optimization problem, because it needs only a method to evaluate fulfillment of its solution problem without any knowledge. To suit a particular application, GA is usually modified. An enhancement to the “traditional” genetic algorithm offers quick and best searches for GAs which cannot relate on average chromosome convergence. The “traditional” genetic algorithm consists of a fitness method, a selection criteria, crossover and mutation operators that are ruled by fixed probabilities. These steps together give a genetic loop as shown in **Fig. 6**. The average number of global searches and local in each generation is fixed, due to constant probabilities. Thus, the GA provides a fixed convergence rate and hence referred to as the fixed-rate GA.



**Fig. 5** GA - Block Diagram

The simplest GA (**Fig. 5**) consists of five steps:

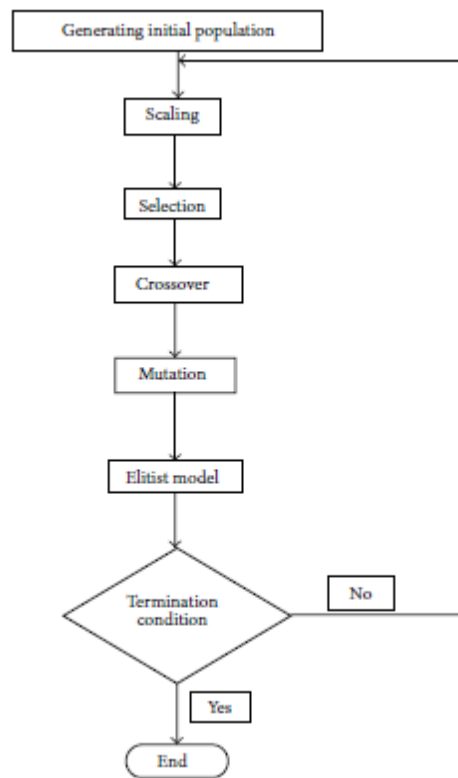
- (i) With a randomly generated population of N chromosomes GA is started, where N is the size of population, l –chromosome length x.
- (ii) Find the fitness value of function  $\phi(x)$  for every chromosome x in the population.
- (iii) Repeat up to N offspring's is formed:
- (iv) Replace current population with newly generated one.
- (v) Then go to step (ii)

### (1) PID Designing using Genetic Algorithm

Genetic Algorithm can be used for PID controller gains tuning explained by Gao Jun–shan et al in order to assure optimality control criteria at general working situations [7].

The differences between Genetics Algorithm and the traditional methods is very essential to study. This will provide an idea why GA is better than the latter. From the more traditional search and optimization techniques, Genetic algorithms are substantially different. The five important comparisons are:

1. Forage a population of points in parallel, not from a single point is done with the help of Genetic algorithms.
2. The direction of the search is pointed by the objective function and suitable proficiency levels. Hence Genetic algorithms do not need past datas or other additional knowledge.
3. Provide probabilistic transition rules, not deterministic rules for Genetic algorithms.
4. Working on the encoding of a parameter set but not the parameter set itself by using Genetic algorithms.
5. Number of potential remedies to a given query and the premier of the final is left up to the user may be provided with the help of Genetic algorithms.



**Fig.6** Genetic Algorithm - Flow Chart

**Table 1** Optimized gain values of PID controller

Gain Coefficient	$K_p$	$K_i$	$K_d$
For population 5	0.3960	0.5320	0.6625
For population 10	0.3760	0.6121	0.0864
For population 15	0.8816	0.6691	0.4491
For population 20	0.9939	0.6888	0.2280
For population 25	0.4077	0.5404	0.3706
For population 30	0.3879	0.2354	0.2931
For population 35	0.4284	0.2618	0.7500
For population 40	0.7488	0.8702	0.2525
For population 45	0.2548	0.2142	0.6529
For population 50	0.0186	3.7281	0.9130

After providing the above parameters to GA (as given in **Table 2**), the PID controller can fine-tuned and this system characteristics shall be enhanced with a population size of 40 is selected.

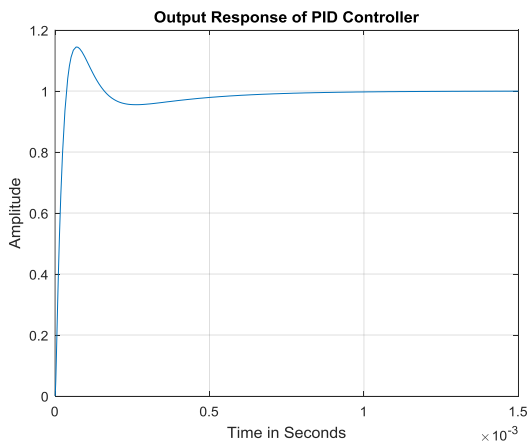
**Table 2** GA Parameters

GA Terms	Value/Method
Size of Population	40
Maximum no of generations	4
Fitness Function /Performance Index	Mean Square error
Selection Algorithm	Normalized Geometric Selection
Probability of selection	0.05
Crossover Algorithm	Arithmetic Crossover
Number of crossover points	3
Mutation Algorithm	Uniform Mutation
Mutation Probability	0.1

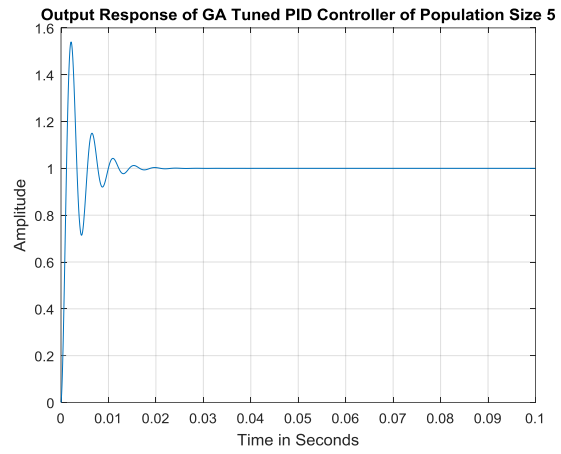
## (2) Proposed Genetic Algorithm PID Controller Results

In this segment, simulation results of the suggested GA tuned PID Controller is given. GA tuned PID controller is initially calculated with population size of 5 and the output is studied. It is then calculated with population size of 10, 15, 20, 25, 30, 35, 40, 45 and 50. The GA tuned PID response will then be evaluated for the required design specifications. The much better response will then be selected as shown in Fig.11 to 14 and the optimized gain values are given in **Table 1**.

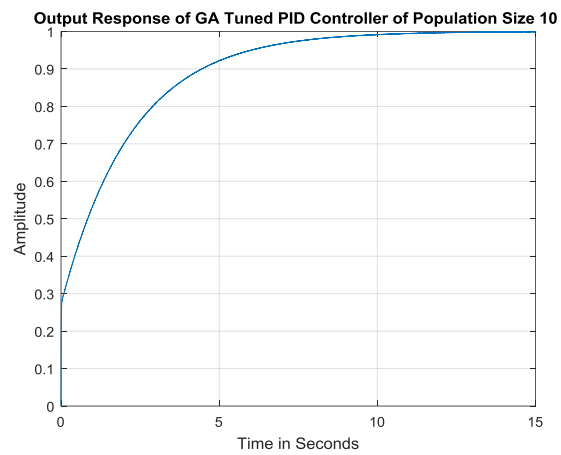
From the calculated responses ie, by comparing the graphs shown in **Fig. 7** and **Fig. 8 to 11**, GA designed PID will have much better response compared to the Z-N tuned PID Method, but has a very large settling and rise time.



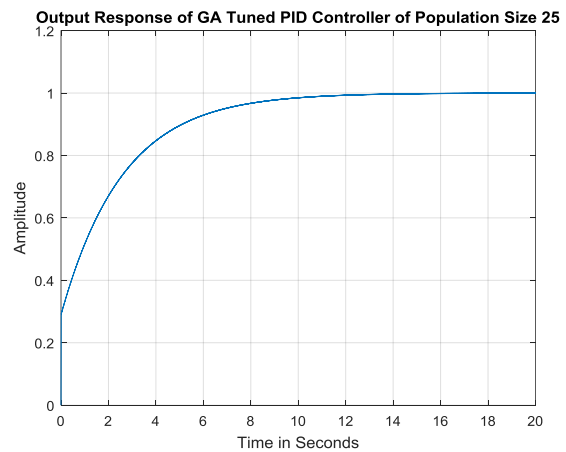
**Fig.7** Output Response of Z-N Tuned PID controller



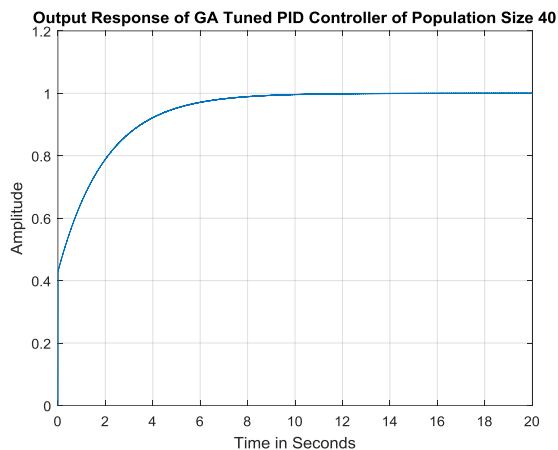
**Fig.8** Output Response of GA tuned PID controller with Population Size of 5



**Fig.9** Output Response of GA tuned PID controller with Population Size of 10



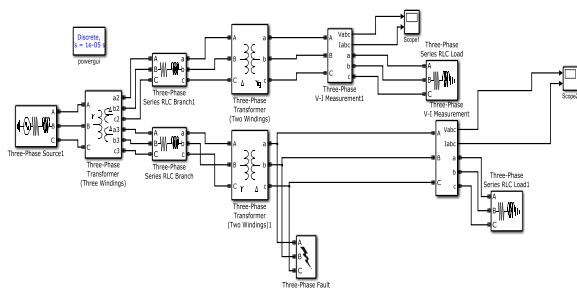
**Fig 10** Output Response of GA tuned PID controller with Population Size of 25



**Fig.11** Output Response of GA tuned PID controller with Population Size of 40

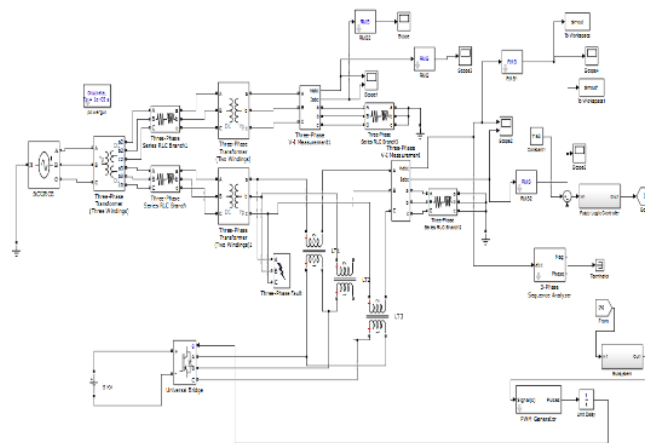
### V. Simulation of DVR with PID Controller and GA Tuned PI Controller

Matlab result has become very important part in the power electronics design process. Main overall system Matlan model without DVR has been developed in Matlab/Simulink as shown in **Fig. 12**. The four control strategies are presented to test the behavior of the DVR in different aspects .



**Fig. 12** Main diagram without DVR.

The test system considered here to run the model for DVR with Neuro Fuzzy Logic Controller is given **Fig. 13**. Such system comprises of 13 kV, 50 Hz generation network, with two feeders at the transmission side with a 3-winding transformer interconnected in Y/ $\Delta$ / $\Delta$ , (13/115/115) kV. Two distribution networks is fed by the particular transmission feeders with the help of two transformers in  $\Delta$ /Y, (15/11) kV connection. The operation of DVR employed for voltage restitutes a fault is applied at point X at resistance 0.66  $\Omega$  for time period of 500 ms. DVR is simulated to be in execution only for the duration of the fault. Dc storage capacity amenity is 5 kV [22].

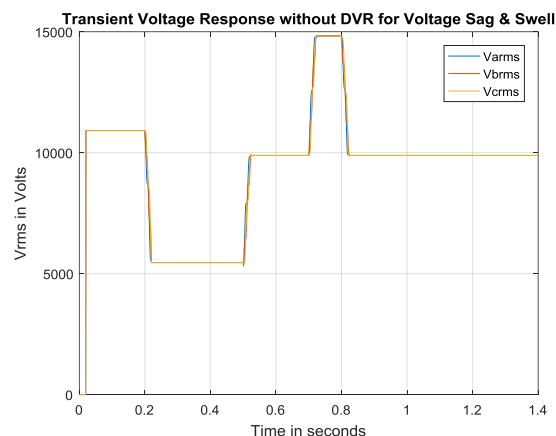


**Fig. 13** Main diagram of DVR with GA Tuned PI Controller.

### VI. Simulation Outputs

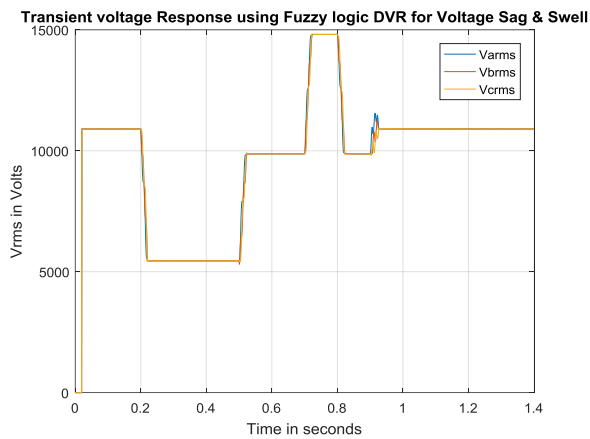
A three phase fault is applying this network at point with a fault resistance of 0.66  $\Omega$  for a time period of 500 ms with no DVR was the first simulation. Consonant situation as above, DVR is now instigate at the load side to compensate requite voltage swell & sags transpire due to three phase fault given is the second simulation

**Fig. 14** shows load side rms voltages when the system works without DVR and a three phase fault is given to the network. When the GA Tuned PI DVR is in execution, the voltage disturbances are indemnify almost downright and the Rms voltage at the subtle load point is controlled normal situation and is shown in **Fig. 15**.

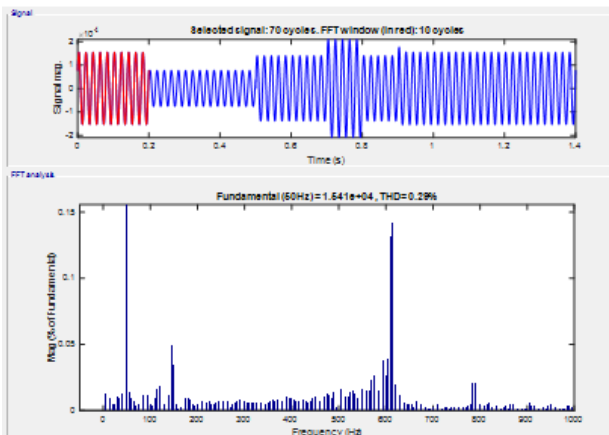


**Fig. 14** Voltage VRMS at the load without DVR

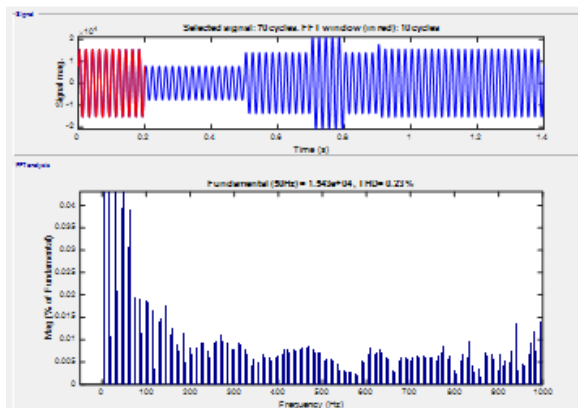




**Fig. 15** Voltage VRMS at the load with GA Tuned PI DVR



**Fig. 16** THD Analysis for ZN Tuned PID Controlled DVR



**Fig. 23** THD Analysis of Population size 40 for GA Tuned PID Controlled DVR

**Table 3** Comparison of Control Algorithms

Type of Control Method	Total Harmonic Distortion (THD) in %
PID Controller	0.29
GA Tuned PID Controller	0.23

The comparison table shown in Table 3 illustrating clearly the effectiveness of GA Tuned Based PI controller in various aspects.

The Total Harmonic Distortion (THD) for all the controllers are good.

## VII. Summary

For keeping the voltage at load side constant, DVR is a newly suggested series type solid state device that inserts voltages into the system. At the point of common coupling, DVR is usually brought together with a distribution system between the supply and the critical load. Other features of DVR are reduction of transients in voltage, line voltage harmonics compensation, and fault current limitations and then check the driving and unvarying performance of DVR, other than voltage sags and swells compensation. The outputs of voltage graphs of DVR using GA Tuned PI Controller with voltage sag & swell during three phase fault are analyzed. DVR with GA Tuned PI Controller performs better than PI based DVR.

## References

- [1] Yun Wei Li, Frede Blaabjerg, D. Mahinda Vilathgamuwa, and Poh Chiang Loh, "Design and Comparison of High Performance Stationary-Frame Controllers for DVR Implementation" IEEE Transactions on Power Electronics, Vol. 22, No. 2, March 2007.
- [2] Ezhilarasan S., Balasubramanian G., DVR for Voltage Sag Mitigation Using Pi with Fuzzy Logic Controller, International Journal of Engineering Research and Application, Vol. 3. 2013.
- [3] Y. Zhao. (Nov. 11, 2016). Electrical Power Systems Quality.
- [4] R. Bayindir, E. Hossain, E. Kabalci, and R. Perez, "A comprehensive study on micro grid technology," Int. J. Renew. Energy Res., vol. 4, no. 4, pp. 1094-1107, 2014.
- [5] Thaha H S, Ruben Deva Prakash, "Reduction of Power Quality Issues in Dispersed Generation & Smart Grids", Journal of Advanced Research in Dynamical and Control Systems Vol. 9. Sp- 18 / 2017.
- [6] Nagaraj B., Subha S., and Rampriya B "Tuning Algorithms for PID Controller Using Soft Computing Techniques", IJCSNS International Journal of Computer Science and Network Security, VOL.8 No.4, pp.278-281, 2008.

- [7] Gao Jun-shan, Mu Xiao-guang, and Yang Jia-xiang, "PID controller based on GA and Neural network", *Electric Machines and Control*, Vol 8, No 2, pp.108-111.
- [8] Melanie Mitchell. (1999), "An introduction to genetic algorithms", Fifth printing, MIT Press.
- [9] Ge S.S., Lee T. H., and Zhu G. (1996), "Genetic algorithm tuning of Lyapunov-based controllers: An Application to a Single-Link flexible Robot System", *IEEE transaction on industrial electronics*, Vol. 43, No.5.
- [10] Thaha H S, Ruben Deva Prakash, "Reduction of Power Quality Issues in Micro-Grid Using Fuzzy Logic Based DVR", *International Journal of Applied Engineering Research*, ISSN 0973 -4562, Vol 13, Number 11 (2018) pp. 9746-9751.
- [11] Bingsen Wang, Giri Venkataramanan and Mahesh Illindala, "Operation and Control of a Dynamic Voltage Restorer Using Transformer Coupled H-Bridge Converters", *IEEE Transactions on Power Electronics*, Vol. 21, No. 4, July 2006.
- [12] Bingsen Wang and Giri Venkataramanan, "Dynamic Voltage Restorer Utilizing a Matrix Converter and Flywheel Energy Storage" *IEEE Transactions on Industry Applications*, Vol. 45, No. 1, January/February 2009.
- [13] Changjiang Zhan, Vigna Kumaran Ramachandaramurthy, Atputharajah Arulampalam, Chris Fitzer, Stylianos Kromlidis, Mike Barnes and Nicholas Jenkins, "Dynamic Voltage Restorer Based on Voltage-Space-Vector PWM Control" *IEEE Transactions on Industry Applications*, Vol. 37, No. 6, November/December 2001.
- [14] Changjiang Zhan, Atputharajah Arulampalam and Nicholas Jenkins, "Four-Wire Dynamic Voltage Restorer Based on a Three-Dimensional Voltage Space Vector PWM Algorithm", *IEEE Transactions on Power Electronics*, Vol. 18, No. 4, July 2003.
- [15] Chris Fitzer, Atputharajah Arulampalam, Mike Barnes and Rainer Zurowski, "Mitigation of Saturation in Dynamic Voltage Restorer Connection Transformers", *IEEE Transactions on power electronics*, vol. 17, no. 6, november 2002.
- [16] Hirofumi akagi, Yoshihira kanazawa and Akira nabae, "Instantaneous Reactive Power Compensators Comprising Switching Devices without Energy Storage Components", *IEEE Transactions on industry applications*, vol. ia-20, no. 3, may/june 1984.
- [17] H. Ezoji, M.Fazlali, A.Ghatresamani and M.Nopour, "A Novel Adaptive Hysteresis Band Voltage Controller for Dynamic Voltage Restorer".*European Journal of Scientific Research* ISSN 1450-216X Vol.37 No.2 (2009), pp.240-253.
- [18] Jing Shi, Yuejin Tang, Kai Yang, Lei Chen, Li Ren, Jingdong Li and Shijie Cheng, "SMES Based Dynamic Voltage Restorer for Voltage Fluctuations Compensation", *IEEE Transactions on Applied Superconductivity*, Vol. 20, No. 3, June 2010.
- [19] Mostafa I. Marei, Ehab F. El-Saadany, and Magdy M. A. Salama, "A New Approach to Control DVR Based on Symmetrical Components Estimation" *IEEE Transactions on Power Delivery*, Vol. 22, No. 4, October 2007.
- [20] Pedro Roncero-Sanchez, Enrique Acha, Jose Enrique Ortega- Calderon, Vicente Feliu, and Aurelio García-Cerrada. "A Versatile Control Scheme for a Dynamic Voltage Restorer for Power-Quality Improvement" *IEEE Transactions on Power Delivery*, Vol. 24, No. 1, January 2009.
- [21] S.R. Naidu D.A. Fernandes, "Dynamic voltage restorer based on a four-leg voltage source converter" *IET Gener. Transm. Distrib.*, 2009, Vol. 3, Iss. 5, pp. 437-447.
- [22] Teke K. Bayindir and M. Tumay, "Fast sag/swell detection method for fuzzy logic controlled Dynamic Voltage Restorer" *IET Gener. Transm. Distrib.*, 2010, Vol. 4, Issue. 1, pp. 1-12.