

# Real time Implementation of IOT for Monitoring DC bus and to analyze the Technical Feasibility of using BLDC wind Generator for RO based Desalination Applications

**B.Shanthi saravana,**

Department of Electrical and Electronics Engg, Bharathidasan Engineering College, Nattarampalli

**K.Mala**

Department of Electrical and Electronics Engineering, Easwari Engineering College, Chennai 1bavinisundar@gmail.com,

Email: mala\_ezhilan@gmail.com

**Abstract:** This paper deals with IOT based BLDC wind power generation and a novel algorithm for maximum power point tracking to maintain stability in output is implemented. In India water scarcity is a vital social problem. Hence the analysis is focused on the feasibility of using non grid wind power to large scale desalination systems. Since RO based desalination is found to be efficient with wind power, pumping system for RO process which is taken as the load. The analysis proved to give a stable output for the fluctuating wind velocities between 8m/sec to 12 m/sec . This shows a new way to increase the wind power generation in INDIA. It eliminates the current disadvantages of wind generation such as increase in cost, complexity in design and instability. In India research in this area is not adequate compared to solar power generation. To implement ease of control Internet Of Things is implemented for the control of DC load. This paper analyses the technical feasibility of implementing non grid wind power to pumping system for reverse Osmosis desalination with a novel MPPT using ANFIS algorithm for a BLDC wind power generation system. To reduce the complexity dc power is utilised for DC load applications. In this paper the simulation and prototype results are analysed and proved to be efficient.

**Key words:** BLDC, desalination, DC load , IOT

## I. INTRODUCTION

In India around 20 percent of people are without access to electricity. Available potential of wind power is around 100GW. But most of the wind generation units are connected to grid which leads to

only 40percent of wind utilization. Because of the fluctuating nature of wind, stability is a big challenge. Since connected to grid the design for higher capacity power generator becomes complex and costly. To overcome all these problems stand alone .BLDC wind generation is suggested replacing PMSG which is being used Today India stands in fourth place in the world in wind power generation. In the year 2022 the demand is expected to increase up to 60 GW. In India still 20 % of the population is living without access to electricity. Wind power is the best way to bring clean energy with low cost. In places where there is no grid connection standalone wind power generation is found to be efficient. Also abundant of wind energy is available and if used to large scale industries like desalination the emission of GH Gases also reduced to save the country. Desalination of seawater to get the drinking water through Reverse Osmosis process is proved to be efficient with renewable source. Hence pumping of sea water to the plant and pumping it through the membrane for reverse osmosis process requires large power which is the reason for very less number of desalination units in India. Pumping the clean water to storage tanks and pumping the salty water into sea with around 500m interior into the sea requires pumping power. In India the electricity charges are keeping on increasing. Also the ratio of people without access to electricity and clean water is also increased with rapid increase in population .The installed wind power generation plants in the year 2017 is around 5.4 GW and total wind power generation has reached only 31 GW where the demand is around 60 GW. China faced the same problem in previous years but overcome the crisis during 1990 by

making intense funded projects of finding the feasibility to install non grid wind powered large scale industries like desalination, Electrolysis of Hydrogen, Alkaline industries and Aluminium industries. Now China is in first position because of its intense research in non grid wind power concept with dc power by reducing the complexities in design of large capacity wind generators and the increased the utilization of wind energy without grid connection. In Tamil Nadu the installed wind power capacity is around 7154MW which is 38percent of total power generation in India. . only 13 percent of wind energy is utilized with the available wind power potential in India. The main problem faced is the grid connection increased cost, complexity in design and depend on developed countries for technology and capacity of grid remains the same over many years. When the grid is saturated with other sources of power the wind generation is forced to stop the generation. Around 50million units are wasted in Tamilnadu since the grid capacity is not increased with increase in population and demand. Hence an innovative way to increase the utilization of wind power is to design more number of standalone applications fed by wind energy. To reduce the cost and complexity in design with AC power DC power applications are suggested. Hence the technology becomes simple and also cost is reduced. But the main drawback is stability of wind power with fluctuating nature of wind power a novel Maximum Power Point Tracking algorithm is used with Serial input parallel output converter which could be used for large scale applications.

## II. EXISTING AND PROPOSED SYSTEM

The existing block consists of PMSG machine and connected to grid. Designing a PMSG generator for large megawatts leads to complexity in design since frequency , phase of output power has to be synchronized with grid. This design technology available only in developed countries and developing countries has to depend on them for technology which increases the cost .But still China stand first in the world in wind power generation because it has developed new concept replacing with BLDC generator and using it for standalone large scale applications with dc loads. Hence in this paper a

simple standalone system with BLDC wind generator is proposed with dc pumping load is proposed. Existing system PMSG is used for wind generation found to be efficient compared to DFIG which is used previously. Now in this paper BLDC generator is proposed which has many advantages.

In this proposed system serial input parallel output converter is used with DC load. Implementation of MPPT control will reduce the response time for DC grid voltage stabilization and gives maximum output with stability. The BLDC generator offers many advantages such as: high efficiency. The BLDC machine is the most efficient since it has a magnetic source inside .The use of permanent magnets does not consume any extra power. Exciter has no copper loss and absence of mechanical commutator and brushes or no slip ring hence mechanical friction losses are minimum.

Compactness of the machine with high-energy density magnets has allowed to achieve the high flux densities in the generator. Also no rotor winding required. Because of these reasons the generator construction is small, light and rugged structure. The advantage in ease of cooling: There is no current circulation in the rotor for magnetic field. Therefore, the rotor of a BLDC generator does not heat up. The only heat production is on the stator, which is easier to cool than the rotor because it is static and on the periphery of the generator. Also the generator has Low maintenance, great longevity, and reliability: The absence of brushes, mechanical commutators and slip rings suppresses the need for associated regular maintenance and suppresses the risk of failure associated with these elements. The longevity refers only to the winding insulation, bearing, and magnet life-length. • There is no noise associated with the mechanical contact. The driving converter switching frequency is high enough so that the harmonics are not audible.

Using BLDC generator with Robustness and reliability which reduces the power losses and so the efficiency is high. ANFIS algorithm is used in this paper to harvest maximum power output. Internet Of Things implemented to monitor the output parameters using mobile. A new hybrid model is generated by genetic algorithm and fuzzy c-means .The Adaptive

neuro- fuzzy inference system (ANFIS) is proposed for Maximum power point tracking. To create this model, three steps are followed up i)optimizing FCM algorithm by using GA, ii)clustering the data set with FCM algorithm and iii)generating the ANFIS classification model.. The model is capable of handling both qualitative and quantitative criteria. The proposed model is applied to a real life problem. Results of the model are compared and analysed forfeasibility.

### III. SIMULATION RESULTS

The proposed system is simulated with BLDC wind generator with ANFIS algorithm , the rectified output is fed to serial input parallel output converter which has the important advantage of Load sharing capability .This could be very well implemented for desalination load which is large scale application. The RO based desalination plantscould be realised in Islands where people are in need of pure drinking water. Many solar based desalination plants are implemented in many countries but wind powered desalination is more efficient and lesser cost compared to Solar plants. The main reason for lesser number of

desalination units in India is its large power requirement and large capital cost. But in this paper the seawater after desalination instead of pumping back to sea could be used as input to salt industries for manufacturing salt. This will make system more feasible costwise.

The simulation output of SIPO converter is given to the DC load. But could also be inverted and given to the ACload. The simulation results show good technical feasibility of using as renewable source for wind speeds between 8 to 12 m/sec with very good stability The simulated results with various wind velocities are analysed. With MPPT the output shows improved stability and maximum voltage. This could be used for standalone systems with complementary battery if needed when the wind velocity is less. The feasibility study has to be carried out before implementing in practical. The design is simple and cost of the system is reduced. In prototype lesserf rating is taken because of the cost constraint and the output results are analysed .DC bus output is monitored with IOT. so that the data could be obtained with IOTfrom remoteplaces.

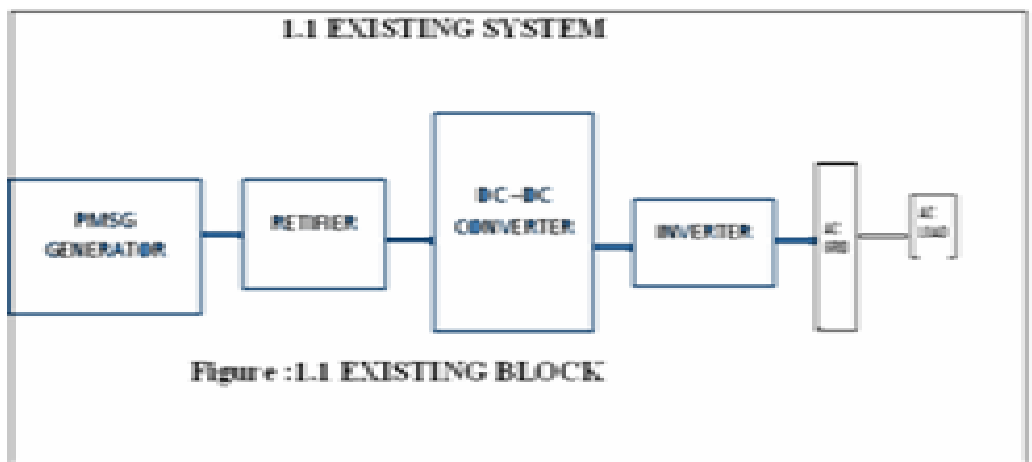

Fig.1. Existing system

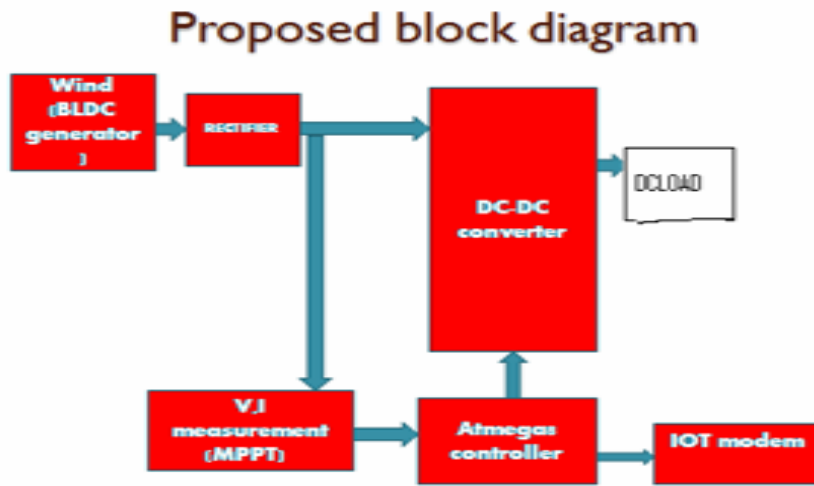

Fig.2. Proposed system

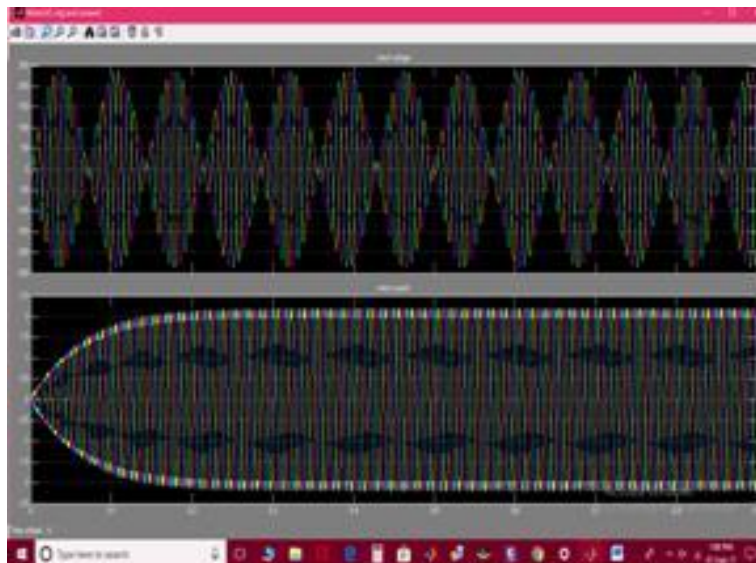
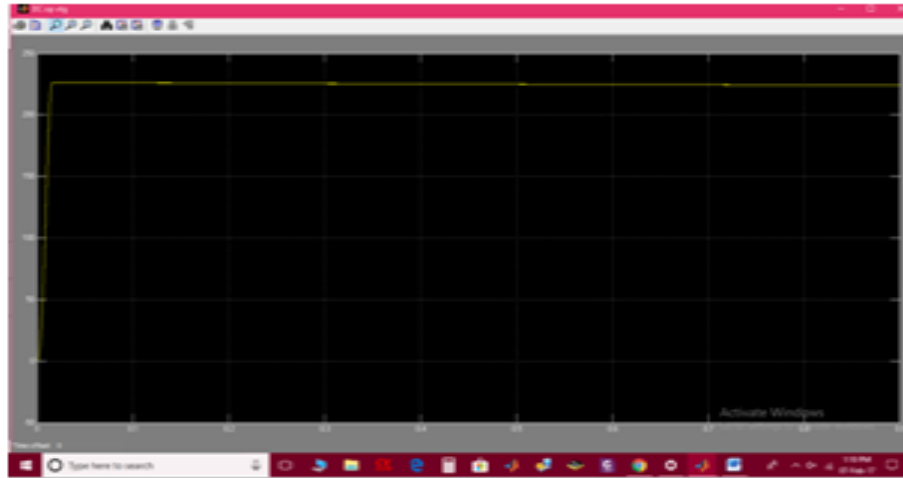

Fig.3. Generator output



**Fig4. Converter output**

Table.1  
Readings of simulated circuit of BLDC generator

WITHOUTMPPT				WITH MPPT			
Speed (m/s)	Voltage (volt)	Current (amps)	Settling time(sec)	Speed (m/s)	Voltage (volt)	Current (amps)	Settling time(sec)
8	160	1.1	0.05	8	230	2.3	0.05
9	180	1.2	0.1	9	230	2.4	0.1
10	210	1.5	0.15	10	230	2.4	0.15
11	220	2.1	0.2	11	230	2.4	0.2
12	230	2.4	0.25	12	230	2.4	0.25



#### IV. EXPERIMENTAL SETUP

IV Prototype model of standalone pumping system with SIPO converter and IOT implementation on real time 220v dc bus system with Dc Rectifier output

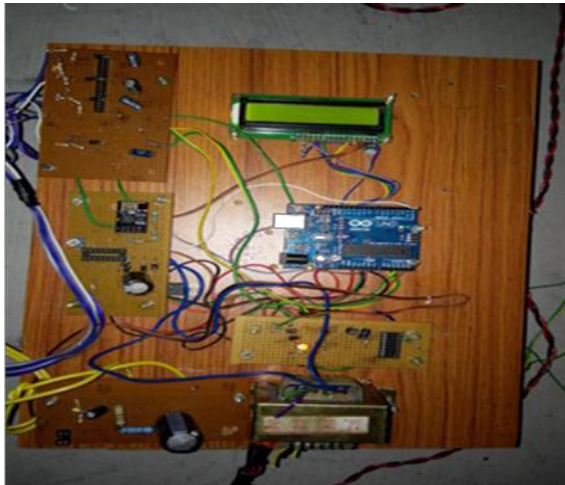

**Fig.3. Hardware circuit for IOT**



**Fig.4. Dc Rectifier Output Voltage Sensor Circuit**

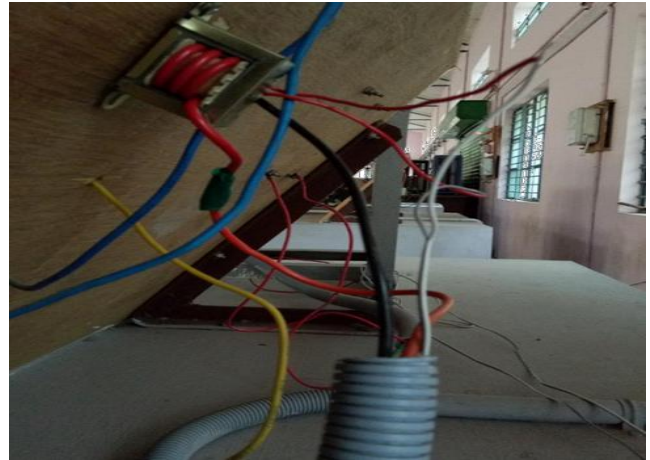

**Fig.5. Current Transformer Circuit**

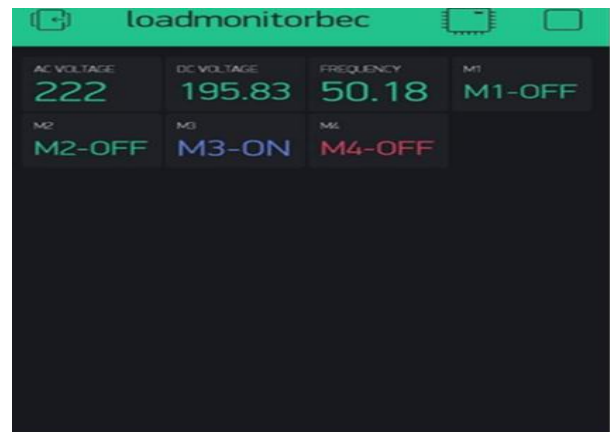

**Fig .6. IOT output in Mobile phone**

The ATmega8 is a low-power CMOS 8-bit microcontroller based on the AVR RISC architecture is used. The controller achieves throughputs approaching 1 MIPS per MHz, allow to optimize power consumption with processing speed. ES P8266 has powerful onboard processing and storage capability that allowed to integrate with sensors and application specific devices through GPIO with minimum development upfront and minimal loading in runtime. Its high degree of onchip integration allows for minimum external circuitry and the entire solution including the frontend module has been designed to occupy minimum PCB area. ANFIS was

built with three basic rules and consists of the selection of fuzzy logic rules If-Then which is a function of fuzzy set membership. Reasoning of fuzzy inference techniques from basic rules to get the output, will work when input contains actual value and is converted to fuzzy values, the fuzzification process where fuzzy value has range between 0 and 1. With the basic rule and database referred as the knowledge base, work are key elements in decision making process. This contains definitions such as information on fuzzy sets parameter with a function that has been defined for each linguistic variable that exist. The database development includes defining of universe, determine the number of linguistic values. ANFIS be used for each linguistic variable to establish a membership function. Based on the rules, it contains fuzzy logic operators and a conditional statement "If- Then." The basic rules can be constructed either from a human or automatic generation, where the searching rules using input-output data numerically. There are several types of FIS, namely Takagi-Sugeno, Mamdani, and Tsukamoto (Cheng et al. 2005). A FIS of Takagi-Sugeno model was found to be widely used in the application of ANFIS method.

## V. CONCLUSION

The technical feasibility analysis for standalone pumping system for desalination applications with BLDC wind power generation was simulated and the results were analyzed. The implementation of MPPT was compared and found to be efficient. The use of wind BLDC generators is found technically much feasible because of its robustness lesser cost and compatibility and reliability which is important factor in wind generation. BLDC machines are technically proved to be feasible to work as generators in non-grid wind generation. Maximum power point tracking with SIPO converter shows good stability in output with variations in wind velocities. Hence fluctuation in wind are overcome and stability in output voltage achieved. This could also be used for large scale standalone systems for which in depth research is required. The simulation results are analyzed and prototype module is constructed for the total setup for smaller rating and with IOT implementation is done realtime for 220v with which the output and status of load is monitored with mobile or system. This part was

implanted in college electrical machines lab DC bus system and successfully tested. The experimental results shows good efficiency and proves to be technically feasible for implementation in wind powered large scale desalination systems.

## Reference

- [1] Ishaque, K., Salam, Z., "A Deterministic Particle Swarm Optimization Maximum Power Point Tracker for Photovoltaic System Under Partial Shading Condition", IEEE.
- [2] Dahmane, M., Bosche, J., El-Hajjaji, A., Pierre, X., "MPPT for Photovoltaic Conversion Systems Using Genetic Algorithm and Robust Control", American Control Conference (ACC), 2013.
- [3] Elgendy, M. A., Zahawi, B., Atkinson, D. J., "Assessment of the Incremental Conductance Maximum Power Point Tracking Algorithm", IEEE Trans SUSTAINABLE ENERGY, Vol. 4, NO. 1, pp. 108-117, JANUARY 2013.
- [4] Suonan, J., Gao, S., Song, G., et al.: "A novel fault-location method for HVDC transmission lines", IEEE Trans. Power Deliv., 2010, 25, pp. 1203-1209
- [5] Nanayakkara, O., Rajapakse, A., Wachal, R.: "Travelling-wave-based line fault location in star-connected multi-terminal HVDC systems", IEEE Trans. Power Deliv., 2012, 27, pp. 2286-2294
- [6] Dewe, M. B., Sankar, S., Arrillaga, J.: "The application of satellite time reference to HVDC fault location", IEEE Trans. Power Deliv., 1993, 8, (3), pp. 1295-1302
- [7] Shang, L., Herold, G., Jaeger, J., et al.: "High-speed fault identification and protection for HVDC line using wavelet technique". Proc. of 2001 IEEE Porto PowerTech Conf.
- [8] J. R. Hendershot Jr. and T. J. E. Miller, Design of Brushless Permanent-magnet Motors, England, Oxford Magna Physics Publications, 1994.
- [9] T. Kenjo and S. Nagamori, Permanent Magnet and Brushless DC Motors, Tokyo, Sogo Electronics Publishing Company, 1994.
- [10] S. J. Park, H. W. Park, M. H. Lee and F. Harashima, "A New Approach for Minimum-Torque-Ripple Maximum-Efficiency Control of BLDC Motor," IEEE Trans. on Industrial Electronics, vol. 47, no. 1, pp. 109-114, Feb. 2000.
- [11] S. K. Safi, P. P. Acarnley and A. G. Jack, "Analysis and Simulation of the High-Speed Torque Performance of Brushless DC Motor Drives," IEEE Proc. of Electr. Power Appl., vol. 142, no. 3, pp. 191-199, May 1995.
- [12] K. F. Rasmussen, J. H. Davies, T. J. E. Miller, M. I. McGilp and M. Olaru, "Analytical and Numerical Computation of Air-Gap Magnetic Fields in Brushless Motors with Surface Permanent Magnets," IEEE Trans. on Industry Applications, vol. 36, no. 6, pp. 1547-1554,

Nov./Dec., 2000.

- [13] The Institute of Electrical Engineers of Japan,
- [14] Motors, Tokyo, Bomundang publications, 2000.
- [15] L. McGrow and C. Pollock, "Low Cost Brushless Generators," in IEEE Industry Application Conference, vol. 2, pp. 1229-1236, Oct. 1999.
- [16] Liu, L., Liu, C., "A Novel Combined Particle Swarm Optimization and Genetic Algorithm MPPT Control Method for Multiple Photovoltaic Arrays at Partial Shading", ASME, Journal of Engineering Resources Technology, Vol. 135, Published on line December 2012.
- [17] Ramaprabha, R., Mathur, B.L., "Intelligent Controller based Maximum Power Point Tracking for Solar PV System", International Journal of Computer Applications (0975 - 8887), Vol. 12, No. 10, January 2011.
- [18] Chiu, C.S., "T-S Fuzzy Maximum Power Point Tracking Control of Solar Power Generation Systems", IEEE TRANS ENERGY CONVERSION, Vol. 25, NO. 4, pp. 1123-1132, DECEMBER 2010.
- [19] ESRAM, T., Chapman, P.L., "Comparison of Photovoltaic Array Maximum Power Point Tracking Techniques," IEEE Transactions on Energy Conversion, Vol. 22, No. 2, June 2007.
- [20] Xiao, W., Zeineldin, H.H., Zhang, P., "Statistic and Parallel Testing Procedure for Evaluating Maximum Power Point Tracking Algorithms of Photovoltaic Power Systems," IEEE Journal of Photovoltaics, Vol. 3, No. 3, pp. 1062-1069, July 2013.
- [21] Ritesh Dash, Pratik Ranjan Behera, S. M. Ali, "Hybrid system for meeting global energy demand with solar PV and wind system", Control Instrumentation Communication and Computational Technologies (ICCICCT) 2014 International Conference on, pp. 388-392, 2014.
- [22] Ritesh Dash, S.M. Ali, Aryadhara Pradhan, Anoop Kumar Mohanta, "Hybrid System for Meeting Global Energy Demand", Computational Intelligence & Communication Technology (CICT) 2015 IEEE International Conference on, pp. 709-713, 2015.
- [23] Adil Usman, Deepjyoti Dutta, Odunsi Habeeb, Addoh Jean, "Sustainable energy in rural communities of Bongouanou: Utilizing solar energy as a source for electricity", Global Humanitarian Technology Conference: South Asia Satellite (GHTC-SAS) 2013 IEEE, pp. 15-20, 2013.
- [24] Arshiya Fathima, M. Nargis Banu, K. V. Kandasamy, S. Padma, K. Sudha, "Standalone hybrid energy harnessing system for light load applications", Green Computing Communication and Conservation of Energy (ICGCE) 2013 International Conference on, pp. 584-589, 2013.