

MODELING AND ANALYSIS OF GCP BASED PV SYSTEM WITH ZINC-AIR BATTERY STORAGE FOR COMBAT VEHICLES

R.Kishore Kumar¹, Dr.P.Sivachandran², Dr.M.V.Suganyadevi³

¹Research Scholar, Center for Research, Anna University, Chennai.

²Professor, Vel Tech Multi Tech Dr.Rangarajan Dr.sakunthala Engineering College, Chennai.

³Associate Professor, Saranathan College of Engineering, Trichy.

^{1,2,3} email id: kishore8192@gmail.com, sivaranjaniuma@gmail.com, mvsuganyadevi@gmail.com

Abstract: *Combat vehicles are mainly dependent on diesel combustion engine and battery bank for power demand in remote areas for monitoring and controlling electrical equipments, sensors, control systems and communication devices etc. In the proposed system existing diesel combustion engine is integrated with GCP (Green Colored Polycrystalline) solar panel and Zinc-Air battery. Among various kinds of solar panels the GCP panels are difficult to track or see from satellite and easy to hide from enemies. A perturbs and observes MPPT algorithm is implemented in MATLAB/SIMULINK environment. The Zinc-Air batteries are embedded in the combat vehicles to provide a continuous power for long time in remote areas without any intermittence. In night time Zinc-Air battery "inhales" oxygen from the free air which acts as the cathode reactant. The virtually limitless supply of air enables the zinc air cells to offer continuous power and it has many performance advantages compared with lithium ion battery. The cost and loss investigations were carried out using PVsyst 6.5.2 and HOMER software.*

Key words: *GCP, Perturb and Observe algorithm, Zinc-air battery, HOMER.*

1. INTRODUCTION

The worldwide fuel consumption [1] by every transport vehicle and combat vehicle has increased rapidly and estimated that the increase in fuel consumption is 41 percent during last century. Now the fossil fuels (liquid and natural gas) are been the primary energy source for the present scenario. Sustained urbanization, industrialization, and increased use of vehicle for every purpose lead to price increment. Demand in fuel led to unprecedented dependency on fuels. Presently, the most important concerns regarding fuels are the harmful gas emissions and the irreversible depletion of natural resources.

Based on the energy statistics the global carbon dioxide emissions will increase by 39 percent to reach 40.4 billion metric. Emission and pollution are the key concern with traditional vehicle. Liquid fuels used in vehicle produce carbon dioxide, sulfur dioxide and nitrogen oxides in day today life. Present vehicle use a diesel or petrol engine where it

converts the chemical energy into mechanical energy but the availability of fuel will be less in upcoming years. The carbon di-oxide emission from vehicle is more harmful to environment and particularly to the human health, animals [2] [3]. The depletion of fossil fuel reserves has placed a lot of importance on the role of alternative and greener sources of fuels to drive vehicle.

Among various kind of renewable energy [4], solar energy for green power generation and Zinc Air battery for charge storage leads to design the hybrid vehicle. The GCP based solar and Zinc Air battery powered hybrid vehicle will become a promising economical vehicle. It offers many advantages such as incurring no fuel costs, not being polluting, required little maintenance, and emitting no noise. But the output power varies randomly due to fluctuation of solar insolation and climatic conditions in order to overcome the fluctuation Diesel engine driven generator for electrical energy is used to provide an uninterrupted energy sources during emergency.

Diesel engine driven generator is coupled with PV for power compensation. Then the system convert all the resources in to one form typically DC electrical power and according to the required load condition it can be modified using inverters. The aggregated output is used to supply a variety of loads used in a system to drive all electronic and electrical devices connected in combat vehicle like sensors and monitoring devices.

PV completely disappears during the night hours and Zinc Air battery produce continuous energy with help of by in-haling oxygen. It works as a compensator to the fluctuating power output of the photovoltaic array. The design process of hybrid energy systems requires the power management controller for selection of the most suitable combination of power sources. Generating the power with help of solar panel and Zinc Air battery reduces carbon di-oxide emission.

In this proposed paper Modeling software is discussed in section II, solar PV one diode model is made in section III, The green colored solar cell characteristics and structure is explained in section IV to VI, Zinc-Air battery construction in section VII and followed by MATLAB SIMULINK Model mathematical modeling and Simulation result of proposed system is shown in section VIII.

2. MODELLING SOFTWARE

The HOMER Micro power Optimization Model [5] and PVsyst is a computer based model to assist in the design of Micro power systems, PV cell and to facilitate the comparison of power generation technologies across a wide range of applications. PVsyst and HOMER simplify the task for using renewable energy resources. HOMER [6] models a power systems physical behavior and its life cycle cost which allows the power systems designer to compare many design options based on their technical and economical merits.

Inputs to HOMER and PVsyst [7] contain preloaded data, renewable energy sources data such as solar radiation and system component specifications and costs, and other information regarding optimization.

3. SOLAR PV MODELLING

It is significant to build an effective PV model before going on to the part of the system. The modeling makes the design and testing much easier. It also helps in the better understanding of the behavior of a PV module under varying atmospheric conditions. The proposed single diode is most common model which helps to understand the PV module performance and characteristics.

The model consists of a current source I_{pv} , a diode D, series resistance R_s and a shunt resistance R_p and it is shown in Fig.1. The values of I_{pv} and I_0 can be computed analytically with the help of the following equations:

$$I = I_{pv} - I_d - \left(\frac{V_d}{R_p}\right) \quad (1)$$

$$I = I_{pv} - I_0 \left(\exp\left(\frac{V + IR_s}{aV_t}\right) - 1 \right) - \left(\frac{V + IR_s}{R_p}\right) \quad (2)$$

$$I_{pv} = (I_{scn} + K_i * (T - T_n)) * \left(\frac{G}{G_n}\right) \quad (3)$$

$$I_0 = \frac{I_{pv}}{\left[\exp\left(\frac{V_{0cn} + K_v(T - T_n)}{aV_t}\right) - 1 \right]} \quad (4)$$

Where I_{scn} = short circuit current at STC,

K_i =current temperature coefficient

T_n =temperature at STC i.e. 25C,

G_n =irradiation at STC i.e. 1000 W/m2,

T = surface temperature of the module,

G = irradiation in W/m2,

V_{ocv} =open circuit voltage at STC,

K_v = voltage temperature coefficient,

a = diode ideality constant,

V_t =thermal voltage

Which is given by $V_t = \left(\frac{N_s * k * t}{q}\right)$.

(R_s , R_p and a) is very essential to model the PV characteristics accurately. As they are not specified in the datasheet, calculation of these values has to be performed; either via analytical method or optimization technique [8].

In this proposed work, Bacterial Foraging Algorithm is used and obtained the parameters values as $R_s = 0.270 \Omega$, $R_{sh} = 500\Omega$ and $a = 1.2$. The accuracy of extracted parameters value experimental values are also entrenched in the graph.

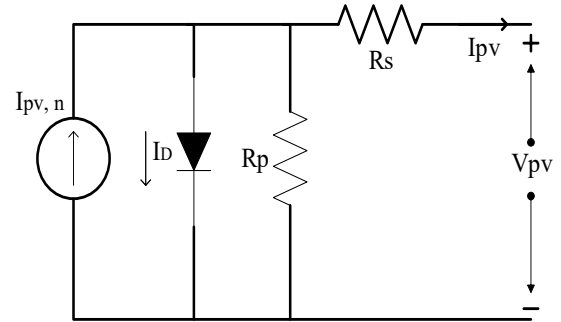

Fig.1. Equivalent circuit of single diode model

4. ANALYSIS OF PV CHARACTERISTICS

A nearer examination of the simulated V-I and P-V characteristics corresponding to dissimilar irradiances are shown below in Fig 3 to 10 expose that power output of the PV module. The PV current increases with increase in voltage after reaching the maximum power point then it start decreasing. The curve joining maximum power points of all possible irradiances is the actual MPP locus is represented. It can be inferred from the figure that there is a significant change in the maximum output power. When change in irradiation occurs there will be with small amount change in PV voltage takes place.

5. GREEN COLORED PV CELL

A Green colored photovoltaic Cell [9] is composed of two electrodes the anode and the cathode. These electrodes are made of a special glass that has a (TCO) Transparent Conductive Oxide coating on one side. The Transparent Conductive Oxide material is a thin layer of FTO fluorine-doped tin oxide. The transparency of the substrate allows sunlight to get into the cell while their conductive surfaces collect charges.

The anode is the negative terminal of the green colored photovoltaic cell. It essentially bears an uninterrupted arrangement of sintered titanium dioxide Nano-particles. This porous arrangement gives an inner surface that is a thousand times better than the flat surface area and acts like a light sponge in which sunlight can get trapped.

Titanium dioxide is a white semiconductor that is not responsive to visible light so, the Titania particles have to be sensitized with a layer of Synthetic Ruthenizer Green dye molecules is used so, the cell stay in green color with all electrolytes (Iodine or Cobalt) it will appear similar to army green color which absorb light in the visible spectrum. Synthetic green colored dye is used to make solar cell green as well as to absorb visible light. The main advantage of this cell is very robust and stable

The positive terminal of the green colored solar cell, also called the cathode, is coated with a catalytic matter for electron transfer, here catalyst is carbon in order to reduce the cost and to increase the material availability carbon is used as catalyst, since a less quantity of catalyst is needed, the electrode remains transparent.

The gap left among the two electrodes is crammed full with an electrolyte that ensures charge moving through a Redox couple. Iodide/Tri-Iodide in a Nitrile solvent is used for this purpose. Eventually, the two electrodes are sealed jointly to prevent the electrolyte solvent from evaporating. However, the assembly can stay open when simplicity is preferred over durability. Nature likes to keep opposite charges jointly so that matter appears neutral.

The photovoltaic effect violates this rule. It creates a separation of charges in the solar cell under illumination. In a green colored Solar Cell, this charge separation happens at the interface of the titanium dioxide and the Synthetic Ruthenizer Green colored dye. The interface is present all over the internal surface of the porous layer. This allows the green colored photovoltaic Cell to produce a number of separated charges which produce an electric current, for a given solar cell area. The structure of the green colored Solar Cell is one of the secrets of its efficacy.

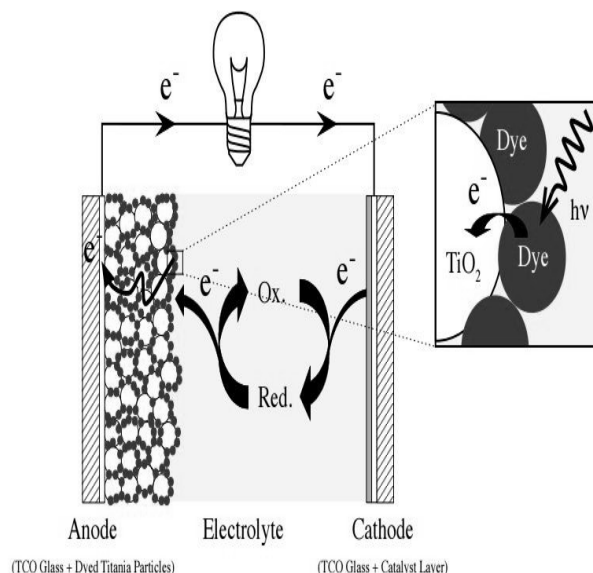

Fig.2. Solar Cell Structure

The green colored Synthetic dye molecules have the ability to absorb visible light. As they are excited by this phenomenon, the molecules will provide an electron and inject it into the titanium dioxide. The charge separation happens when the electron is injected into the Titania and the “hole” is left behind on the Synthetic dye molecule. Not amazingly, nature hates to have these charges separated. The electron must return to the oxidized Synthetic dye molecule as soon as possible. That's where kinetics comes into play the fastest route back to the dye for the electron is to travel through the outer circuit. It might be a longer path to take the highway, but it's faster than a footpath.

An electron injected will travel through the titanium dioxide particles and get to the TCO glass of the anode, the negative terminal of the solar cell. When a load is connected, electrons immediately move to the positive terminal of the solar cell, the cathode, via the external circuit so this movement of electrons is what we call an electric current and produce a (voltage range 0.6 Volt) for single cell according to illumination of the sunlight and environment condition it varies.

The redox couple presents in the electrolyte, electrons can ultimately be transported from the cathode to the oxidized synthetic dye molecules [10]. Now that the charges are together again, again new cycle is formed as long as the sun shines. This is how a green colored Solar Cell produces electricity by photovoltaic separation of charges.

The waveform from figure 3- 9 shows the I-V characteristic and P-V characteristic of the green colored solar cell.

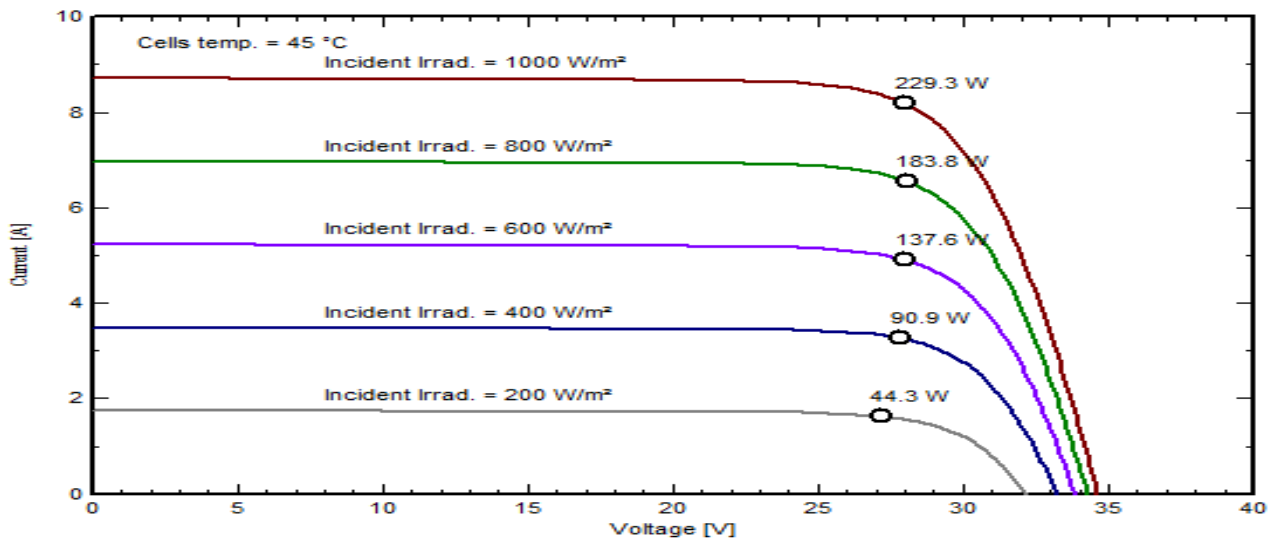

Fig.3. (Current vs. voltage) Incident Radiation

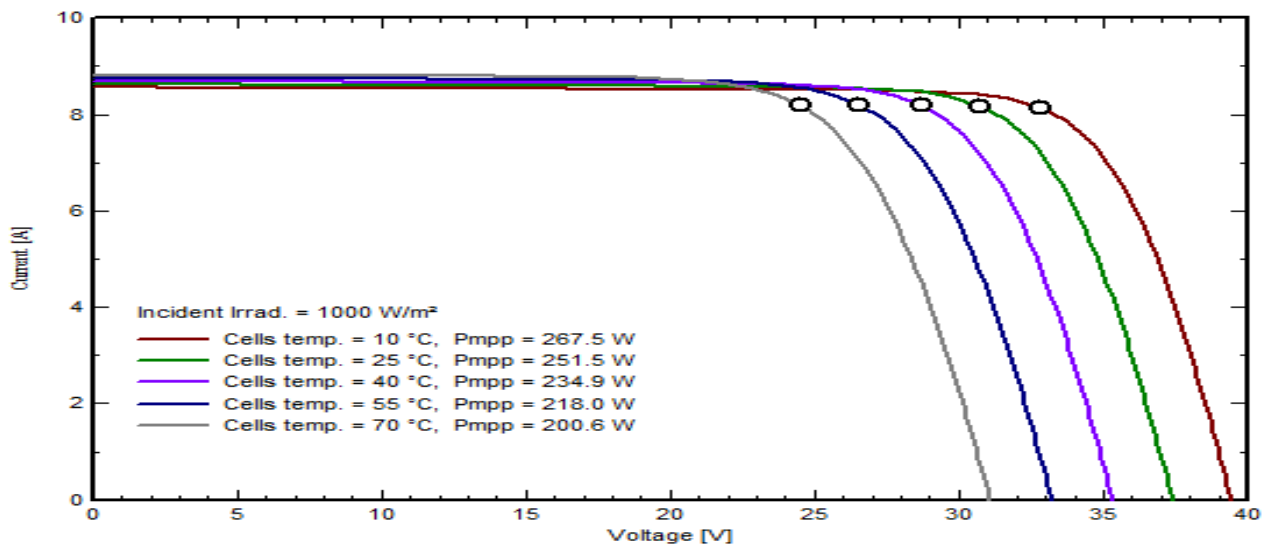

Fig.4. (Current vs. Voltage) Temp-Measurement

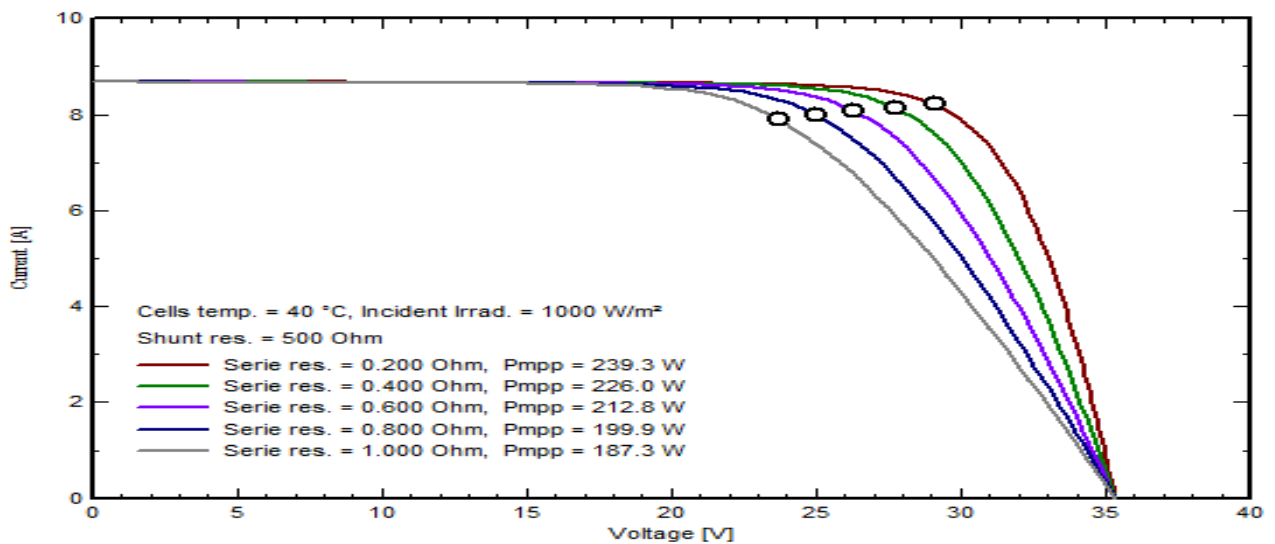

Fig.5. Shunt Resistance Measurement

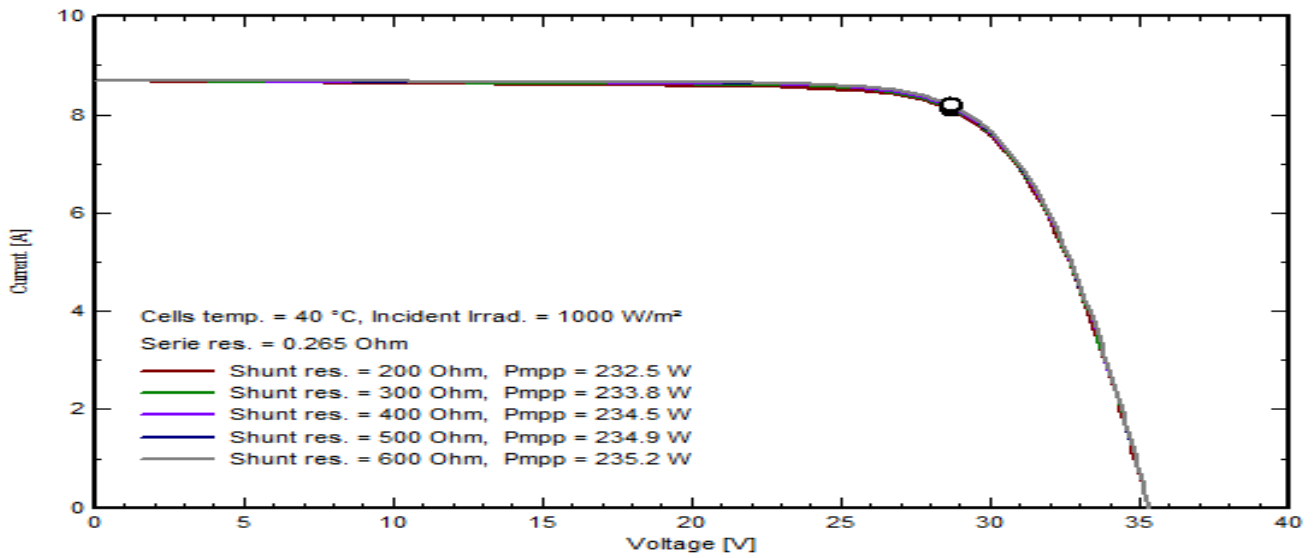

Fig.6. Series Resistance Measurement

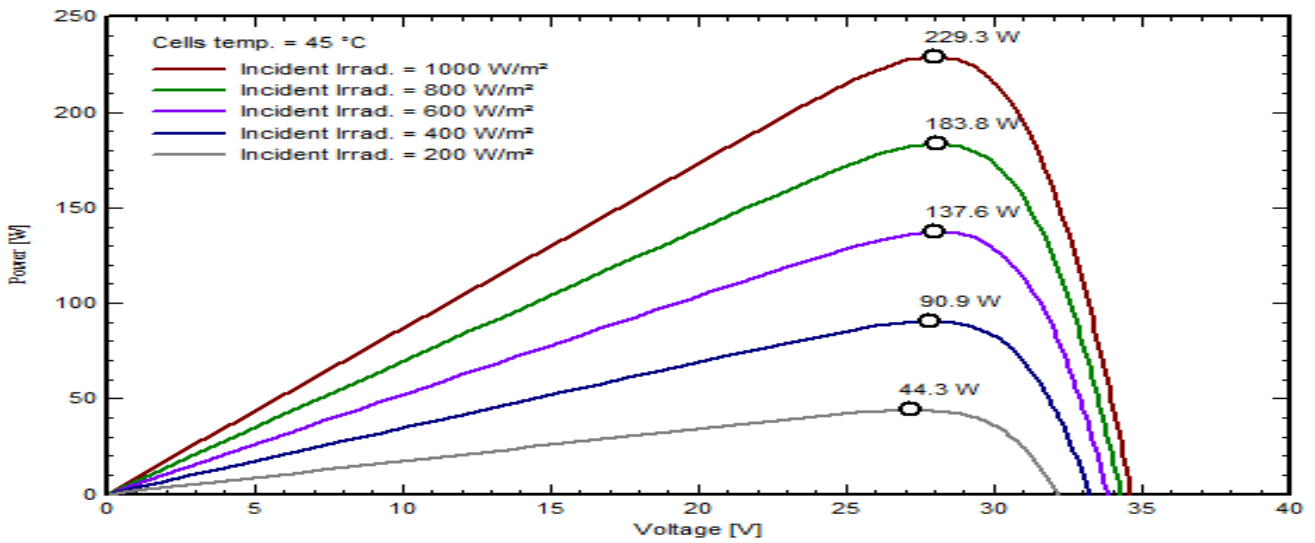

Fig.7. Incident Radiation Measurement

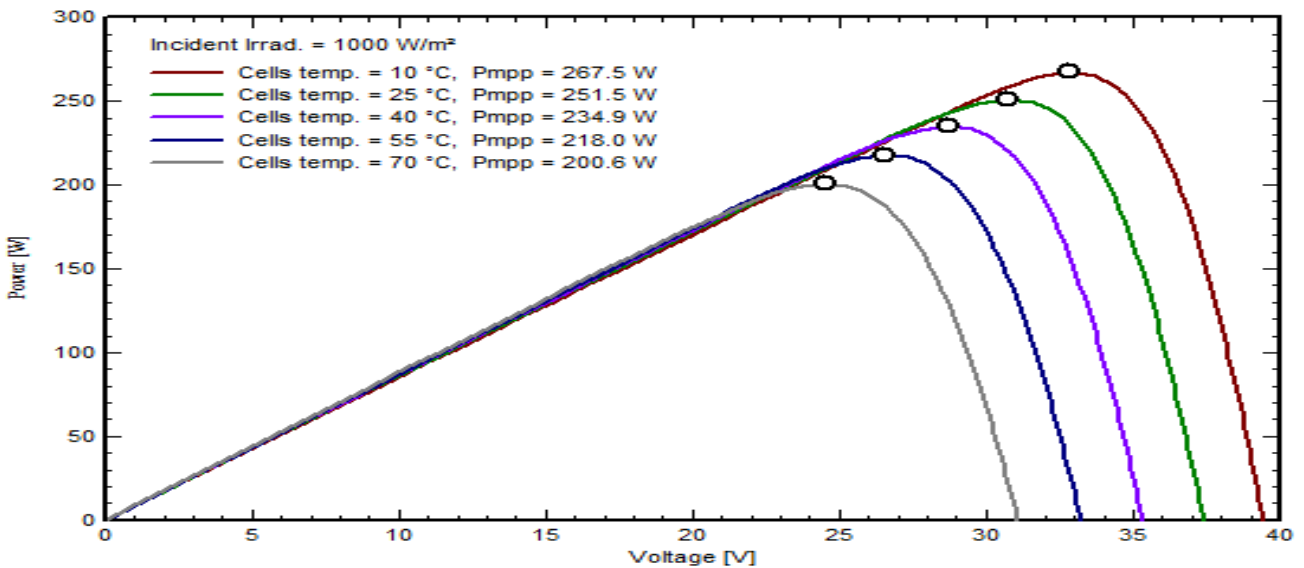

Fig.8. Cell Temperature Measurement

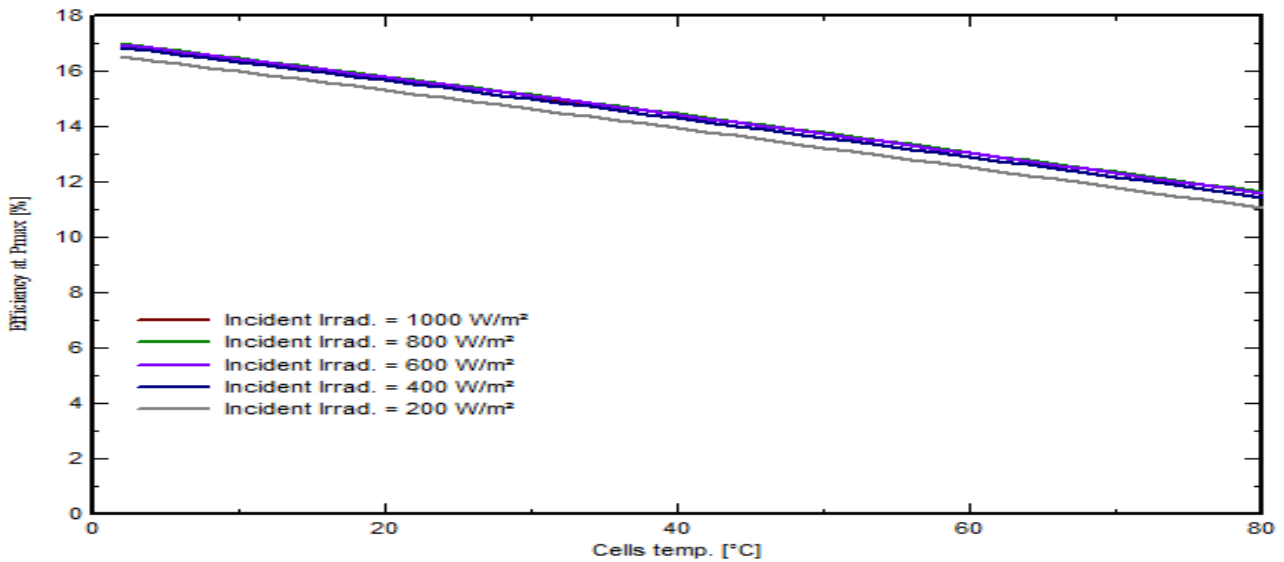

Fig.9. Efficiency Measurement

6. Global horizontal radiation

The global horizontal radiation shown in below figure 10 is the imported data from HOMER software and it varies according to various region and environment condition. It is the daily radiation vs clearness index from January to December month.

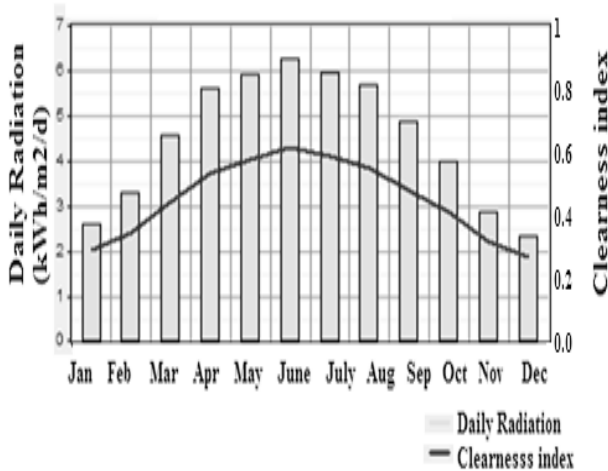

Fig.10. Global horizontal radiation data

7. ZINC-AIR BATTERY

Zinc-air Battery storage system plays a vital role in a world in small power application. It is device made up of electrochemical cells that are used to convert chemical energy to electrical energy and Vice-versa. The zinc-air battery system is different from most other batteries in that it uses oxygen from the air act as the cathode reactant. Basically, the vast supply of air allows the zinc air cell to offer many

performance advantages compared to other conventional batteries [11]. Zinc air battery works like other conventional batteries because they generate electrical power from chemical reactions. Zinc air battery gets one of their main reactants from oxygen from the outside air as shown in figure 11. Oxygen molecules enter the cell through tiny holes in the top and then comes to contact with positively charged (cathode) made of porous carbon. Water and other molecules present in pores of the electrode react with the oxygen to produce hydroxyl ions. These hydroxyl ions migrate through an air separator to a negatively charged electrode (anode) that consists of a zinc gel [12]. These hydroxyl ions bond to zinc molecules to form zincate and then suddenly split into a water molecules and zinc oxide and then releasing electrons to travel through a circuit to Supply charge.

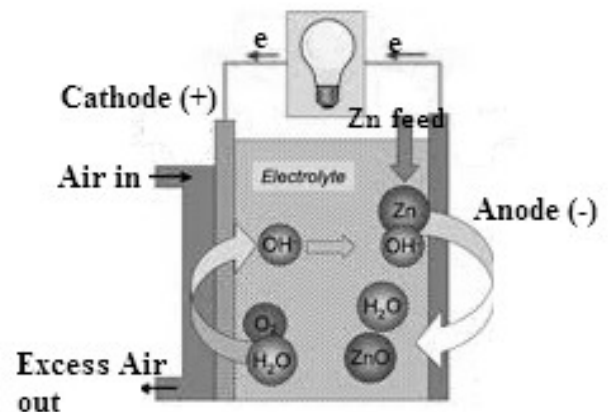
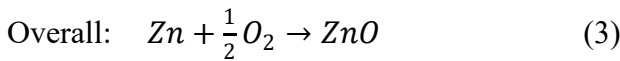
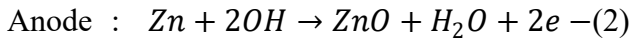
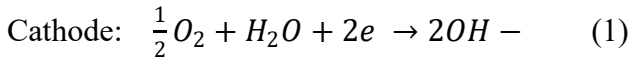

Fig.11. Zinc air Battery

Zinc-air batteries are more striking because of the low cost of zinc metal, non-flammable in nature and also safer to operate. Primary (non-rechargeable) zinc-air batteries have been commercialized for medical and telecommunication applications with limited power density.

However it remained great challenge for improving the performance but it leads to develop secondary rechargeable batteries to improve the efficiency, robust air substances and also to improve the lifecycle of the zinc electrodes to achieve maximum efficiency.

Zinc-air rechargeable battery innovation comes under the original design of the bi-directional air cathode that could recharged for 10,000 cycles (or around three decades) and also its initial battery could cost 160 \$/kWh, expected lifetime could near 30 years and made up of everyday usable materials. The overall reactions for a Zinc air battery are as follows,



Unlike any other power sources, Zinc air technology acts to absorb carbon di-oxide, therefore reducing ambient CO₂ level and purify the air.

Zinc electrode can be produced without polluting environment, thus Zinc-air battery with no emissions of CO₂ can be produced. Compared to the various conventional batteries like Lead-acid, Nickel Metal Hydride, Lithium ion and Zinc air, zinc air battery have high energy density, Competitive with Lithium-ion, Inexpensive materials, Flat discharge voltage and Safety can be obtained in a various range of sizes and with maximum environmental benefits. Figure 12 shows energy density benchmarking of various battery chemistry.

Compare to conventional Lithium ion battery, Zinc air battery has the following advantages, Zinc air battery could store the electrical power as twice as that of Lithium-ion Because of its high efficiency, it could replace Lithium-ion. Zinc air battery could be low cost (160 \$/kWh) alternative to Lithium ion (180 \$/kWh) and comparison are shown in table I data for comparing initial cost and operating cost.

TABLE I

S.No	Battery	li-ion	Zinc air
1.	Initial Capital Cost	1,20,000	90,000
2.	Operating Cost	5000	2000
3.	Total Net Present Cost	1,25,000	92,000
4.	Life cycles	8000	7000

Table I: Comparison of Li-Ion and Zinc Air Battery

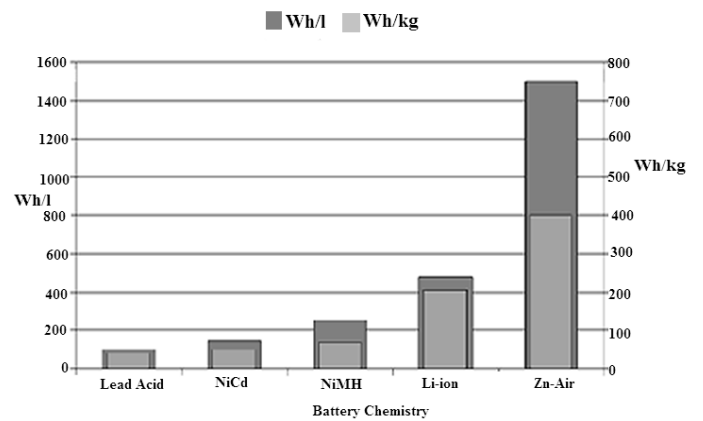

Fig.12 Energy Density Benchmarking

The schematic block diagram shown in fig 13 Shows that diesel engine generator is coupled with renewable energy according to demand of the load. It helps to optimize the system and to control the rate of flow of power with help of this control method. It is studied and implemented in the proposed combat vehicle model.

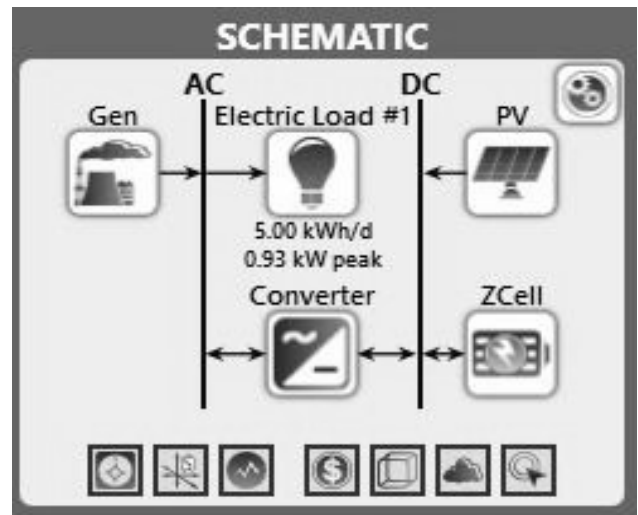

Fig.13 Schematic Block Diagram

The Zinc Air battery state of charge is mainly depend on the oxygen content in the air the below figure 14 shows the battery state of charge of daily profile from January to end of the year December.

The data imported from HOMER the shows graph that whenever there is presence of oxygen in the environment it continuously produces the power without any intermittence even during night time.

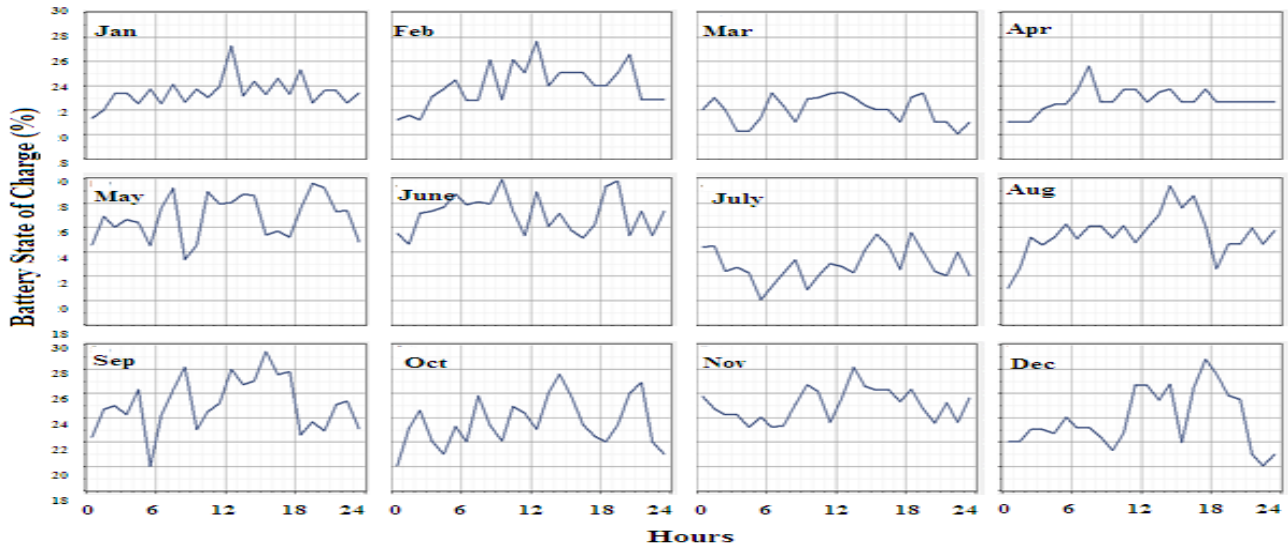

Fig.14. Battery State of Charge of daily profile

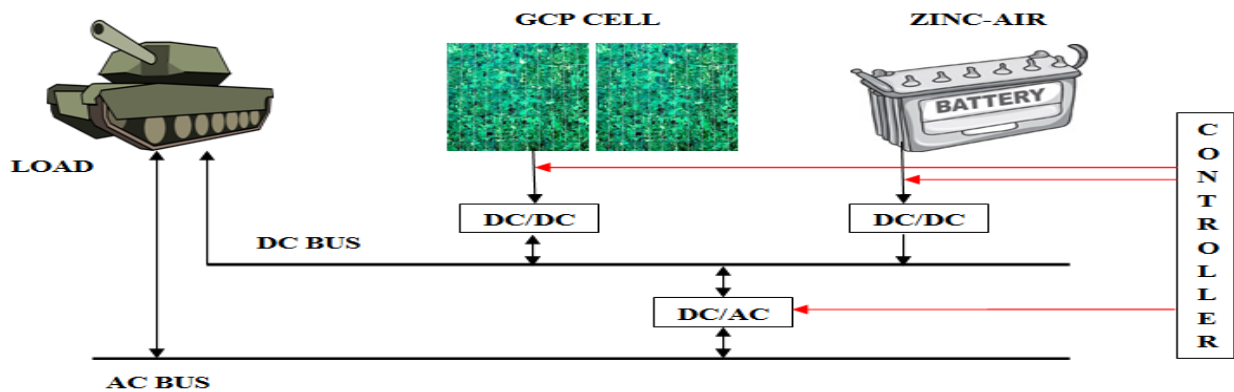

Fig.15. Block Diagram

The block diagram of the proposed system is shown in above figure 15 states that green colored solar cell produce DC power in day time. Generate DC power with help of MPPT and produced power is passed through DC/DC converter. To obtain the constant power, Zinc air battery act as a power bank during night time. It produces the charge ions by absorbing the oxygen from the environment and delivers the power according to the load demand. The zinc air battery power is coupled to DC/DC converter to obtain continuous power the without any intermittence.

The diesel engine is coupled with synchronous generator it act as secondary AC power source. It can be converted into dc power during emergency condition and connected with dc load through

rectifier.

The table II shows the comparison of various colored solar cell with green color solar. It shows the maximum power, voltage, current, open circuit voltage, short circuit current, module efficiency, maximum power voltage, power tolerance, power management accuracy, No. of cells connected in series, diode value, and overall efficiency of green colored solar cells (60 cells) connected in series achieves the maximum power of 240wp. It can be implemented in combat vehicle for power generation in remote areas in day time without any intermittence.

The small module of the individual cell produces about (0.6 volt/cell) according to the requirement of the load the cell size and number can be increased.

TABLE II (COMPARISON OF VARIOUS MODULE)

Electrical Data	Black	Brown	Red	Lavender	Emerland Green	White	Gold	Blue	Green
Maximum Power P_m (w)	235	233	236	235	236	232	229	235	240
Voltage V_m (v)	29.4	29.5	29.9	29.4	29.5	29.7	28.9	29.4	30
Current I_m (A)	8.0	7.9	7.9	8.0	8.0	8.0	7.9	8.0	8.0
Open Circuit Voltage V_{oc}	37.6	37.5	37.7	37.8	37.6	37.6	37.7	37.9	37.6
Short Circuit Current I_{sc}	8.4	8.3	8.2	8.4	8.3	8.4	8.5	8.6	8.6
Module Efficiency (%)	15.8	15.5	15.6	15.4	15.7	15.8	15.5	16.0	16.0
Maximum System Voltage	600	600	600	600	600	600	600	600	600
Power Tolerance	±3	±3	±3	±3	±3	±3	±3	±3	±3
Power Management Accuracy	±3	±3	±3	±3	±3	±3	±3	±3	±3
Cells	60	60	60	60	60	60	60	60	60
Diodes (15 Amps)	15*3	15*3	15*3	15*3	15*3	15*3	15*3	15*3	15*3
Temp-Coefficients	-0.35	-0.35	-0.35	-0.35	-0.35	-0.35	-0.35	-0.35	-0.35

MATLAB SIMULINK MODEL

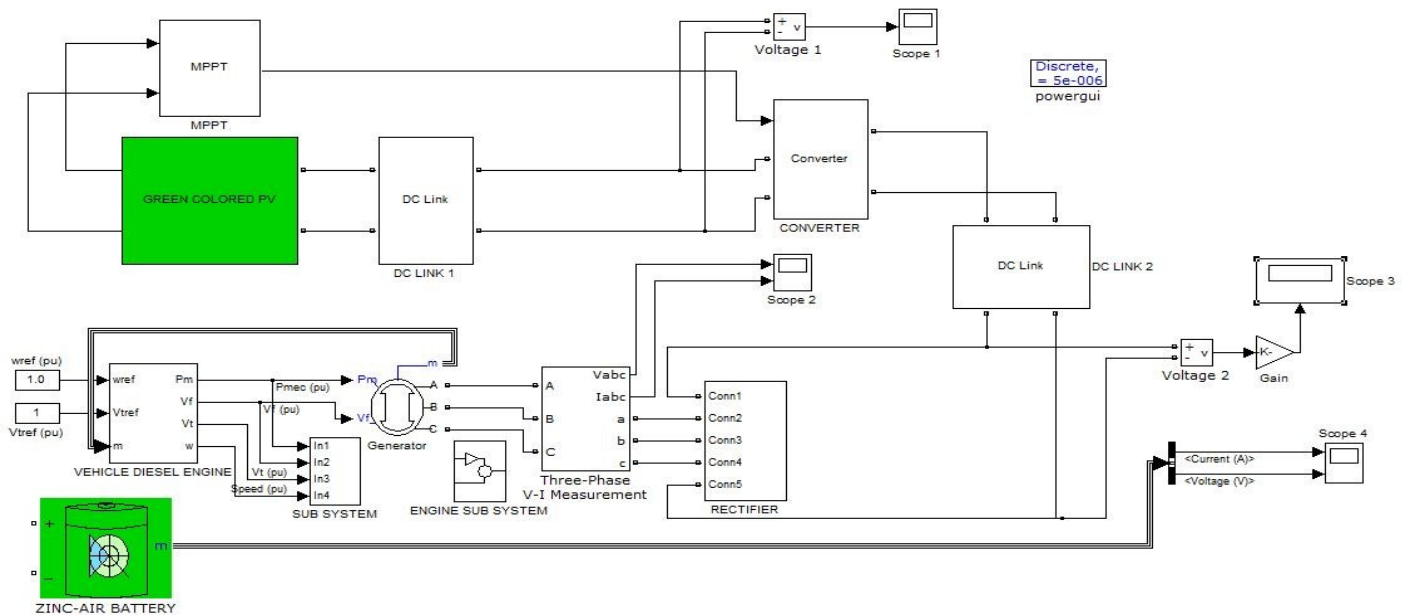

Fig.16.MATLAB SIMULINK Model Diagram

8. MATHEMATICAL MODELLING

The total model is designed power = 1.4KW.

GCP solar PV panel

- Total load requirement = 1,350 W
- Total No of GCP based PV panel = 2Module
- PV open circuit voltage = 35.3Volts
- PV total Power obtained = 260W

Zinc-Air battery

- Battery bank Combination = 1 bank
- Battery voltage = 260Volts
- Battery current = 2amps

Three phase AC Diesel generator

- Three phase AC voltage = 100 volts
- Three phase AC current = 4amps
- Total DC voltage = 890volts
- Total DC current = 1.5amps
- Total generated power = 1335W

9. SIMULATION RESULTS

The model shown in the above figure 16 contains the diesel engine connected with synchronous AC generator. where it produce the pure alternating power whenever the engine is started if the load requires ac power it can be directly used without any conversion process. The combat vehicle most frequently requires only dc power source.

The most of the sensors like temperature sensor, humidity sensor and speed sensor and various monitoring device requires only dc source so the rectifier is employed to convert ac to dc power source.

The green colored photovoltaic cell connected with maximum power tracking device. It extracts the maximum dc power where it is directly connected with common dc bus. Zinc air battery is directly coupled with common dc bus so the power requirement of the combat vehicle in remote areas can be easily achieved. Noise and emission of carbon dioxide are controlled. The fig 17 shows voltage of the green colored photovoltaic cell

voltage without using maximum power point tracker. The Fig 18 shows power and fig 19 shows the voltage and current waveform of battery without load. If the dc load is connected to the system current varies according to the load. The fig20 shows the waveform of the synchronous generator where the three phase voltage and current waveform without connecting any load if load connected to the system waveform automatically varies with respect to time. The fig 21 shows the total voltage waveform from this the dc load can be connected easily without any intermittence. According to the requirement battery and PV cell can be increased to attain the maximum load.

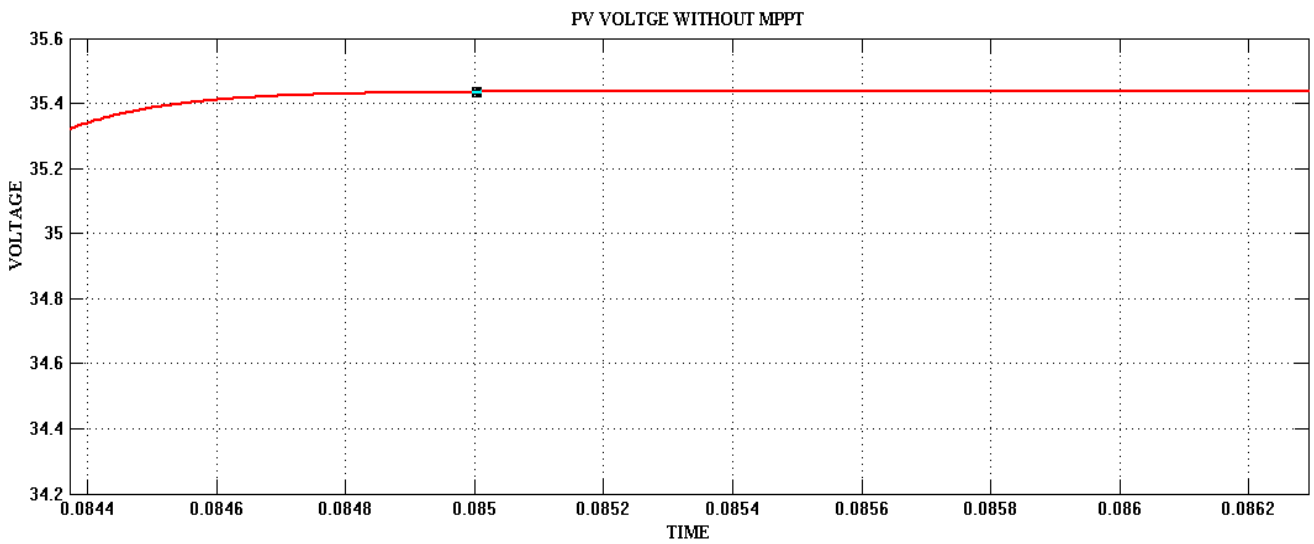

Fig.17. Green Colored Solar cell voltage without MPPT

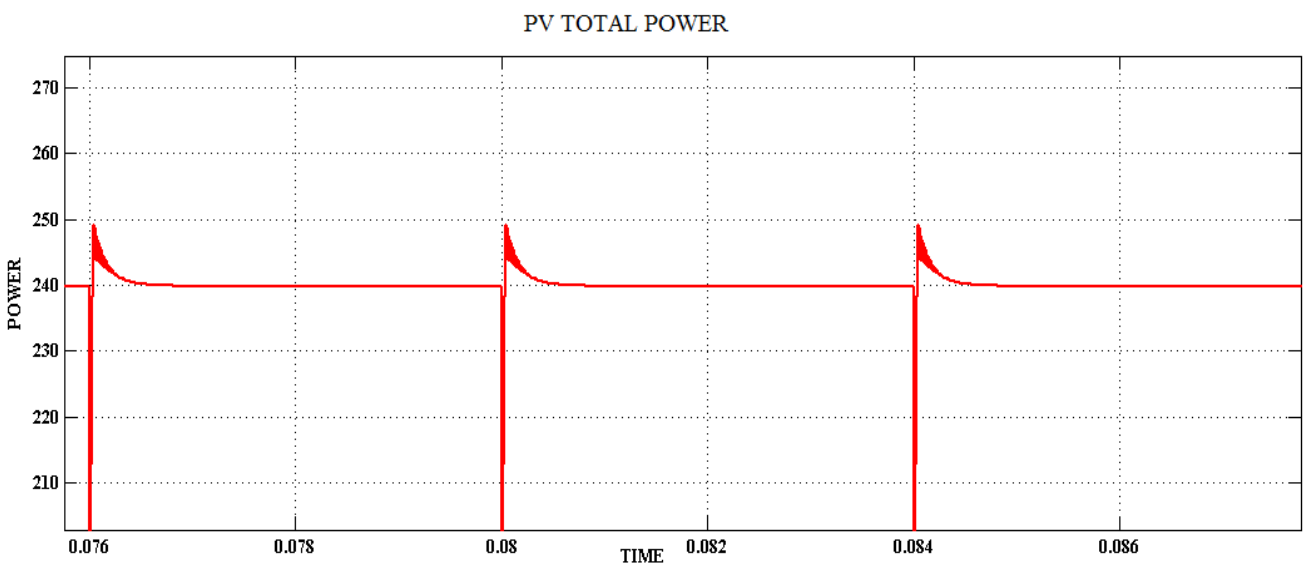

Fig.18. Green Colored Solar cell power with MPPT

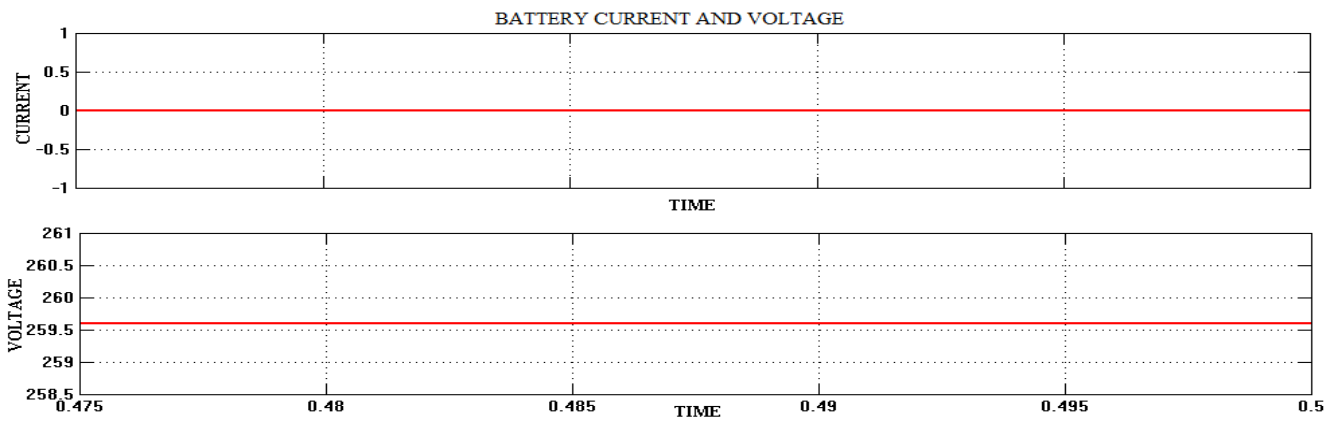

Fig.19.Battery Current and Voltage without Load

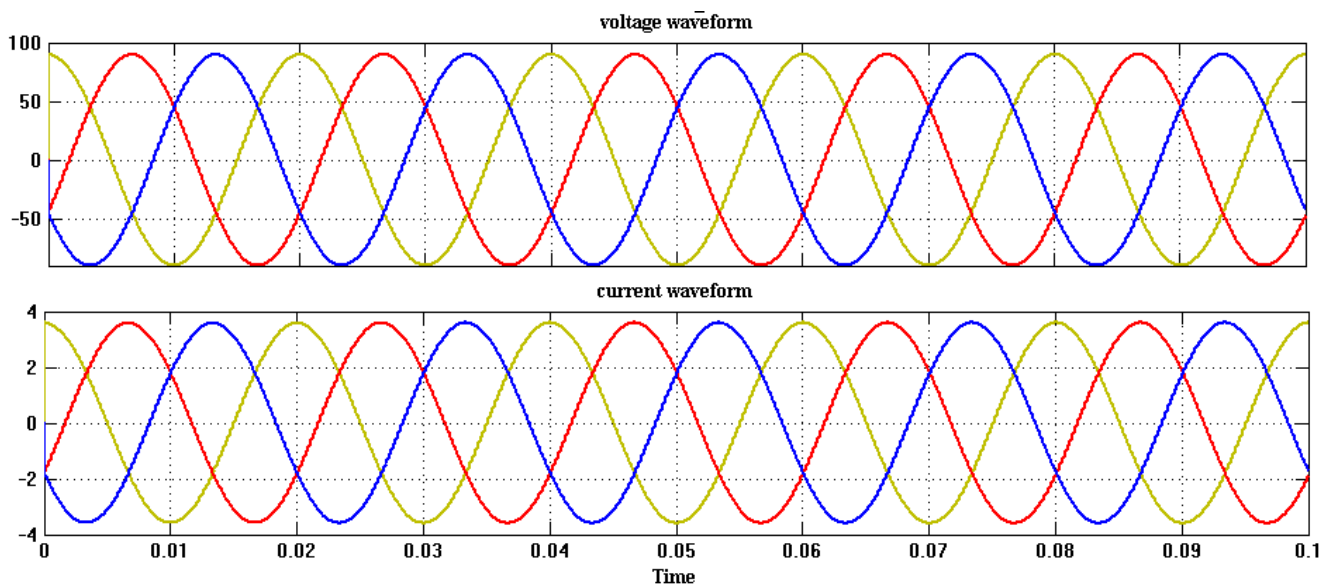

Fig.20.Diesel Generator with Resistive load

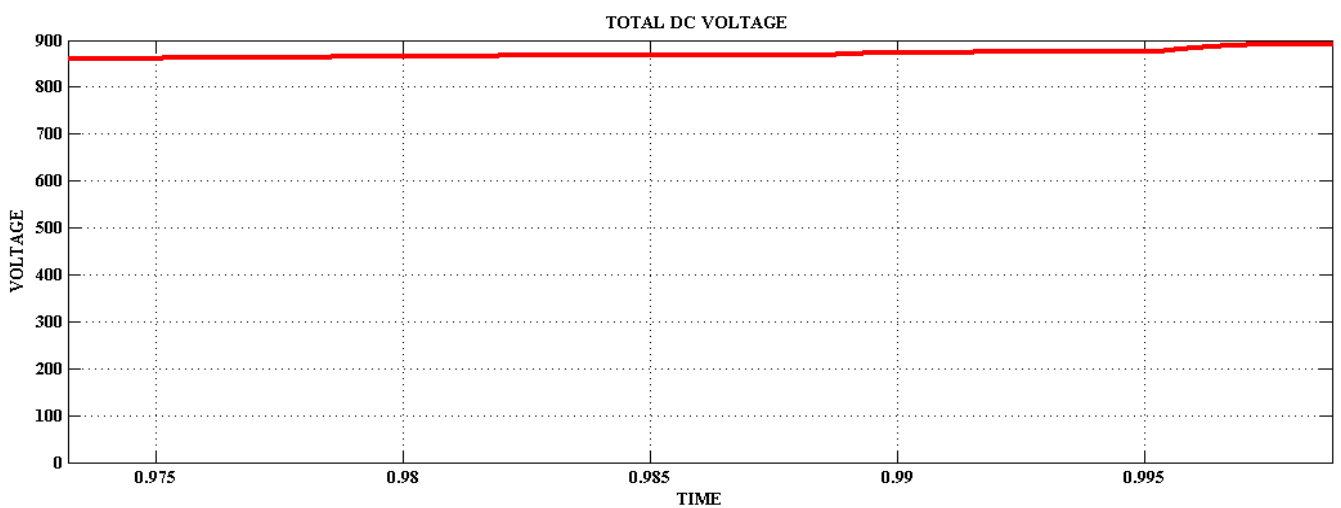

Fig.21.Output Waveform

9. CONCLUSION

Renewable power with latest technology increasingly used in electric vehicle during the past years. Using the diesel engine for long time power production in remote areas produce noise, it consumes large amount fuels and enormous amount of heat. It does not help to hide from enemy. The combination of green colored solar cell and Zinc air battery has become an energy solution for combat vehicle. The zinc-air battery system is different from most other batteries used in electric vehicle it “inhales” oxygen from the free-air for use as the cathode reactant so, the external charging is not required The virtually limitless supply of air enables the zinc air cell to produce power continuously and also offer many performance advantages compared to other batteries. With help of the proposed system the combat Vehicle able to hide from enemy and it is difficult to identify or track the combat vehicle through satellite. The green colored solar cell and zinc air battery deliver power for the entire component connected to the vehicle.

References

1. Fuel Economy State of the World 2016 Time [https://www.google.co.in/webhp?sourceid=chromeinstant&rlz=1C1DFOC_enIN727IN727&ion=1&espv=2&ie=UTF8#q=world+wide+fue+consumption+report&*](https://www.google.co.in/webhp?sourceid=chromeinstant&rlz=1C1DFOC_enIN727IN727&ion=1&espv=2&ie=UTF8#q=world+wide+fue+consumption+report&*&rlz=1C1DFOC_enIN727IN727&ion=1&espv=2&ie=UTF8#q=world+wide+fue+consumption+report&*)
2. Acceleration of global warming due to carbon- cycle feedbacks in a coupled climate model Peter M. Cox, Richard A. Betts, Chris D. Jones, Steven A. Spall & Ian J. Totterdell <http://www.nature.com/nature/journal/v408/n6809/abs/408184a0.html>
3. Global green house gas emission report <https://www.epa.gov/ghgemissions/global-greenhouse-gas-emissions-data>
4. Renewable and Alternative Energy [http://extension.psu.edu/natural resources/solar energy](http://extension.psu.edu/natural%20resources/solar%20energy).
5. “HOMER – Analysis of micro power system options” <https://analysis.nrel.gov/homer>.
6. “HOMER Energy”, [Online] Available at <http://www.homerenergy.com>.
7. PVsyst: Software for Photovoltaic Systems.
8. Rajasekar N, Kumar Neeraja Krishna, Venugopalan Rini. Bacterial foraging algorithm based solar PVparameter estimation. *Sol Energy* 2013; 97:255–65.
9. The New Green Roof: Solar Panels That Change Colors www.takepart.com/article/2016/07/18/new-green-roof-solar-panels-change-colors
10. Bringing color to solar panels – Science Daily <https://www.sciencedaily.com/releases/2013/07/130722105549.htm>
11. [http://www.treehugger.com/files/2009/10/zinc-air-battery-revolt-3-times-more energy-lithium-ion-battery-electric-cars.php](http://www.treehugger.com/files/2009/10/zinc-air-battery-revolt-3-times-more-energy-lithium-ion-battery-electric-cars.php).
12. zinc air battery powerruk http://www.mpoweruk.com/zinc_air.htm.
13. Yan R, Saha TK, Modi N, Masood N-A, Mosadeghy M. The combined effects of high penetration of wind and PV
14. Allan G, Eromenko I, Gilmartin M, Kockar I, McGregor P. The economics of distributed energy generation: a literature review. *Renew Sustain Energy Rev* 2015; 42:543–56
15. Zakeri B, Syri S. Electrical energy storage systems: a comparative life cycle cost analysis. *Renew Sustain Energy Rev* 2015; 42:569–96. <http://dx.doi.org/10.1016/j.rser.2014.10.011>.
16. Chen C, Duan S, Cai T, Liu B, Hu G. Optimal allocation and economic analysis of energy storage system in microgrids. *IEEE Trans Power Electron* 2011; 26:2762–73.
17. Bigdeli N. Optimal management of hybrid PV/fuelcell/battery powersystem: a comparison of optimal hybrid approaches. *Renew Sustain Energy Rev* 2015; 42:377–93. <http://dx.doi.org/10.1016/j.rser.2014.10.032>.
18. Ovrum E, Bergh TF. Modelling lithium-ion battery hybrid ship crane operation. *Appl Energy* 2015; 111.
19. Maleki A, Askarzadeh A. Optimal sizing of a PV/wind/diesel system with battery storage for electrification to an off-grid remote region: a case study of Rafsanjan, Iran. *Sustain Energy Technol Assessments* 2014; 7:147–53. <http://dx.doi.org/10.1016/j.seta.2014.04.005>.
20. Rezzouk H, Mellit a. Feasibility study and sensitivity analysis of a stand-alone photovoltaic–diesel–battery hybrid energy system in the north of Algeria. *Renew Sustain Energy Rev* 2015; 43:1134–50. <http://dx.doi.org/10.1016/j.rser.2014.11.10>.
21. Ramli Ma M, Hiendro A, Twaha S. Economic analysis of PV/diesel hybrid system with flywheel energy storage. *Renew Energy* 2015; 78:398–405. <http://dx.doi.org/10.1016/j.renene.2015.01.02>.
22. Zhao B, Zhang X, Li P, Wang K, Xue M, Wang C. Optimal sizing, operating strategy and operational experience of a stand-alone microgrid on Dongfushan Island. *Appl Energy* 2014; 113:1656–66. <http://dx.doi.org/10.1016/j.apenergy.2013.09.015>.
23. Jeyaprabha SB, Selvakumar a I. Optimal sizing of photovoltaic/battery/diesel based hybrid system and optimal tilting of solar array using the artificial intelligence for remote houses in India. *Energy Build* 2015; 96:40–52.
24. Sharafi M, El Mekawy TY. Multi-objective optimal design of hybrid renewable energy systems using PSO-simulation based approach. *Renew Energy* 2014; 68:67–79. <http://dx.doi.org/10.1016/j.renene.2014.01.011>.