

Power quality and reliability enhancement in distribution systems via optimum network reconfiguration by using star algorithm

A Alwinstar, Research Scholar,

Department of EEE, Arunachala college of engineering for womens, Tamilnadu, India

Dr.S.Joseph Jawhar, Principal and Professor,

Department of EEE, Arunachala college of engineering for womens, TN,India

Abstract

System reconfiguration (SR) is the way toward differing the topological game plan of dispersion feeders by changing the open/shut status of sectionalizing and tie switches. This paper displays a strategy to improve the power quality (PQ) and unwavering quality of dispersion frameworks by utilizing ideal SR. Ideal SR is connected freely to a framework in a specified period to limit the quantity of spread voltage droops (Nsag) and other unwavering quality records, for example, the normal framework intrusion recurrence file, continued normal interference recurrence list, and fleeting normal intrusion recurrence file. The quantum-enlivened twofold firefly calculation (QBFA) is utilized to find the ideal SR. The QBFA performance for the utilization of ideal SR to limit Nsag is first contrasted and other set up improvement techniques, for example, the standard parallel firefly calculation and gravitational inquiry calculation. Contextual investigations are directed by utilizing other target capacities, and unwavering quality evaluation is performed to watch the dependability improvement brought about by the new system topology. Reenactment results demonstrate that the proposed ideal SR viably

upgrades framework dependability level and PQ.

Keywords: Power quality, System reconfiguration, Quantum-enlivened twofold firefly, ASIFI, SAIFI, MAIFI, SARFI, AIFI,

1 INTRODUCTION

A cutting edge electric power framework must be intended to supply satisfactory dimensions of electrical vitality to clients. Basic power quality (PQ) unsettling influence occasions, for example, voltage lists, may cause extensive monetary misfortunes in light of the fact that mechanical procedures depend on electronic influence control gadgets. Burden related lists, for example, the normal framework intrusion recurrence record (ASIFI), and proceeded with interference files, for example, the continued normal interference recurrence list (SAIFI), are the most widely recognized unwavering quality appraisal lists in tending to voltage hang.

Voltage hangs, which are regularly brought about by framework blames that last over 0.01 s, may prompt the breakdown of delicate hardware and procedure downtime. Voltage droop is defined as a decrease in root-mean-square (RMS) voltage size somewhere in the

range of 0.1 and 0.9 pu at spans of 0.01 s to 60 s [10]. Chen et al. [3] utilized a progression of methodologies dependent on system reconfiguration (SR) to relieve voltage droops and improve framework unwavering quality. SARFI can be defined as pursues:

$$\text{SARFI} = \frac{\text{number of lists } \delta N_{\text{sag}}}{\text{all out number of clients served } \delta NT} \quad (1)$$

The quantity of lists in SARFI can be changed into proceeded with interferences, transient intrusions, and burden blackouts to get to framework unwavering quality. ASIFI, MAIFI, and SAIFI can show load-related . They utilized self-versatile modified educator learning improvement (MTLO) to address the multi-target advancement issue simultaneously.

$$\text{ASIFI} = \frac{\text{sum of absolute associated kVA of burden interrupted } \delta Li}{\text{all out associated kVA served } \delta LTP} \quad (2)$$

$$\text{AIFI} = \frac{\text{sum of client momentary intrusions}}{\text{all out number of clients served } \delta NT} \quad (3)$$

SAIFI, normal vitality not provided (AENS), and utility-situated target capacities. The quantum parallel firefly calculation (QBFA) is proposed in the present examination to decide the ideal arrangements [2]. The QBFA calculation is approved by utilizing demonstrated heuristic computational improvement instruments, for example, the standard paired firefly calculation (BFA) and parallel gravitational pursuit calculation (BGSa) [3]. After the adequacy of QBFA for ideal NR and for limiting voltage lists is verified, other unwavering quality files, for example, SAIFI, ASIFI, and MAIFI, are utilized as target works in ideal NR with QBFA. The impact of ideal NR on different target capacities is evaluated by utilizing the voltage hang file SARFI [2]. Unwavering quality evaluation is led by utilizing SAIFI, ASIFI, and MAIFI.

$$\text{SAIFI} = \frac{\text{Sum of all customer continued interruption due to each event}}{\text{total number of customers served } (NT)} \quad (4)$$

ASIFI can be utilized to demonstrate the financial misfortunes brought about by burden out-ages, while MAIFI can be utilized to speak to client interruption on account of assurance gadget activities. SAIFI can be utilized to show supported client interferences.

2. MATERIALS AND TECHNIQUES

This area depicts the vital segments required to perform SR for the improvement of framework PQ and unwavering quality. These segments incorporate the framework list computation, issue formulation for enhancement, proposed advancement technique, and system. Conceivable blame parts, for example, transport and transformer shortcomings, can likewise be examined. In the event that the blame rate of a blamed line with length L is λ_L , the evaluated number of line blames every year f_L can be defined as pursues [1,9]:

$$f_L = \sum_{k=1}^4 \sum_{i=1}^{N_i} L_i \lambda_{Li} \quad (5)$$

where k speaks to the three-stage, line-to-ground, line-to-line, further more, line-to-line-to-ground deficiencies; N L is the all out number of lines in the framework. The yearly number of transformer flaws (f_T) and transport deficiencies (f_B) can be gotten by means of the blame rates. The complete number of deficiencies would then be able to be acquired by utilizing these shortcomings [1,9]:

$$f_{total} = f_L + f_r + f_B \quad (6)$$

N list furthermore, the complete number of intrusions (N int) can be resolved by observing the individual transport voltage size (V I) in the system and identifying the type and location of load bus i. Annual N sag can be obtained as follows [2,10]:

$$N_{\text{sag}} = \sum_{i=1}^{N_{\text{bus}}} \sum_{f=1}^{f_{total}} \begin{cases} 1 & \text{if } 0.1 p.u < V_i < 0.9 p.u \\ 0 & \text{otherwise} \end{cases} \quad (7)$$

The segment of N droop comparing to delicate transports is equivalent to the all out number of proceeded with interferences on the grounds that

generally forms including touchy hardware experience long downtimes. The aggregate number of interferences every year for non-touchy burdens can be gotten as pursues [2,10]:

$$N_{int} = \sum_{i=1}^{N_{bus}} \sum_{f=1}^{f_{total}} \begin{cases} 1 & \text{if } V_i \leq 0.1 \text{ p.u} \\ 0 & \text{otherwise} \end{cases} \quad (8)$$

The interferences featured in Eq. (8) can be partitioned further into proceeded with intrusions

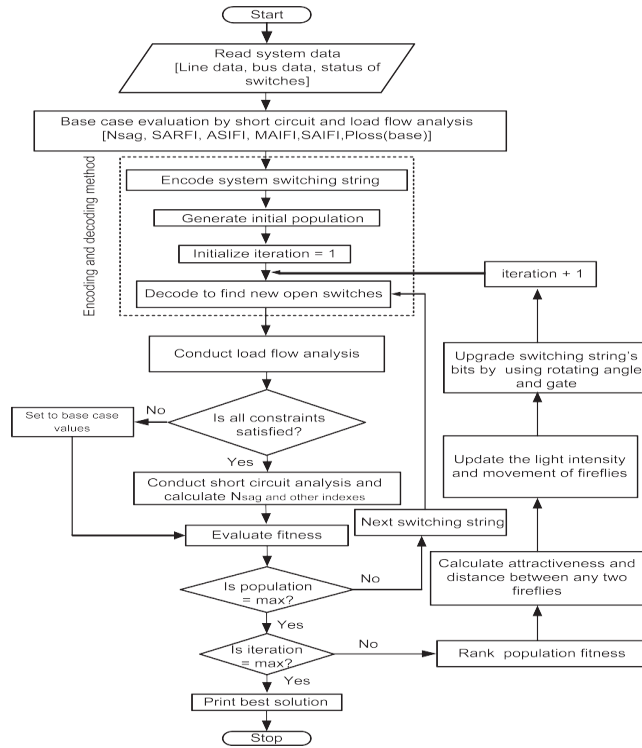

Fig: 1 Flow chart of the proposed optimal SR-star algorithm by QBFA.

if the non-touchy burden transport is the blame transport or on the other hand if the non-touchy burden transport is found downstream from the blame since these transports are segregated when opening the circuit breaker to clear the blame.

3. APPROPRIATION SR

3.1. Proposed QBFA for ideal SR

A paired adaptation of the firefly calculation (FA), that is, QBFA, is created and used to upgrade the NR issue. This procedure maintains a strategic distance from the disadvantages of customary BFA. FA depends on the social

exercises of fireflies. Standard FA considers two imperative parameters, to be specific, variety in light intensity I and the detailing of engaging quality b . At the point when b is proportionate to I , b , which shifts with separation r , can be communicated as pursues [28]:

$$\beta(r) = \beta_o e^{-\gamma r^m}, \quad (m \geq 1) \quad (9)$$

where β_o is the appeal at $r = 0$, γ is the light assimilation coefficient, also, r is the separation between two fireflies.

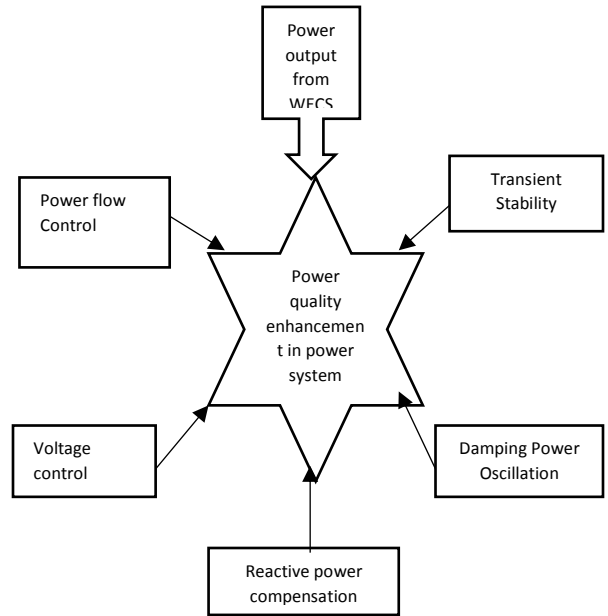

Fig: 2 Collective flowchart for star algorithm

The separation between any two fireflies, i and j , at x_i also, x_j can be communicated as the Cartesian separation r_{ij} :

$$r_{ij} = \|x_i - x_j\| = \sqrt{\sum_{k=1}^d (x_{i,k} - x_{j,k})^2} \quad (10)$$

Where $x_{i,k}$ is the k^{th} component of the spatial coordinate x_i of the i^{th} firefly. A brighter firefly j was attracted by firefly i , this movement was expressed as follows:

$$x_i = x_i + \beta_o e^{-\gamma r_{ij}^2} (x_j - x_i) + \text{alpha} \left(\text{rand} - \frac{1}{2} \right) \quad (11)$$

$$\text{Alpha}(t-1) = \text{alpha}(t) * 0.99 \quad (12)$$

where the second term speaks to the fascination, and the third term compares to the randomization of the randomization parameter. The situation of firefly $i(x_i)$ changes from a paired number to a genuine number when firefly i progresses toward becoming pulled in to firefly j in discrete FA. Hence, the sigmoid capacity $S(x_i)$ appeared in Eq. (13) limits the nonstop yield somewhere in the range of zero and one. The estimation of $S(x_i)$ decides the likelihood that the estimation of bit x_i is "1" as appeared in Eq. 14).

$$S(x_i) = \frac{1}{1 + \exp(-x_i)} \quad (13)$$

$$x_i = \begin{cases} 1, & \text{if } S(x_i) > r \\ 0, & \text{otherwise} \end{cases} \quad (14)$$

Where r is a uniform random variable between "0" and "1". A quantum bit (Q-bit) is the littlest unit in quantum registering and can be either "1," "0," or on the other hand in a direct superposition of the two [6]:

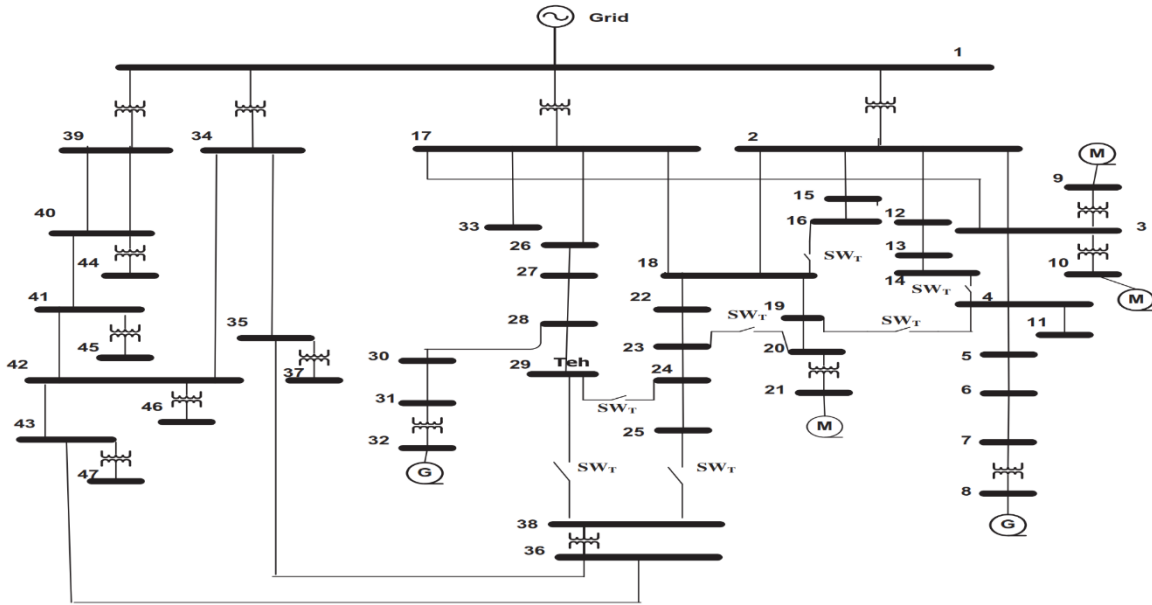

Fig: 3 Actual 47- bus test distribution system.

Table 1: Details of the 47-bus test system.

Bus no.	kV	Load		Load type	No. of customers	Bus no.	KV	Load		Load type	No. of customers
		P MW	Q Mvar					P MW	Q Mvar		
1	132	0	0	0	0	25	11	1.25	0.605	3	125
2	11	0	0	0	0	26	11	0.351	0.149	6	1
3	11	0.85	0.527	1	1	27	11	0.276	0.118	3	28
4	11	0.345	0.194	4	1	28	11	0.314	0.134	4	63
5	11	0.244	0.145	3	24	29	11	0.613	0.261	2	3
6	11	0.244	0.177	3	24	30	11	0.592	0.252	3	59
7	11	0	0	0	0	31	11	0	0	0	0
8	3.3	0	0	0	0	32	6.6	0	0	0	0
9	3.3	1.275	0.513	1	1	33	11	0.032	0.024	6	1
10	0.433	1.594	0.641	1	1	34	33	0	0	0	0

11	11	0.146	0.098	3	14	35	33	0	0	0	0
12	11	0.294	0.143	3	29	36	33	0	0	0	0
13	11	0.488	0.341	2	4	37	11	8	6	5	8
14	11	0.437	0.199	2	4	38	11	7.65	4.741	5	7
15	11	1.776	1.006	2	8	39	33	0	0	0	0
16	11	0.297	0.098	3	30	40	33	0	0	0	0
17	11	0	0	0	0	41	33	0	0	0	0
18	11	0.616	0.43	3	61	42	33	0	0	0	0
19	11	0.388	0.23	3	39	43	33	0	0	0	0
20	11	0.732	0.354	1	1	44	11	12.75	7.902	5	26
21	3.3	1.063	0.427	1	1	45	11	12.75	7.902	5	26
22	11	0.925	0.549	2	5	46	11	6.8	4.214	5	14
23	11	0.582	0.345	2	3	47	11	4.8	3.6	5	10
24	11	0.504	0.23	4	100						

$$|\Psi\rangle = \alpha|0\rangle + \beta|1\rangle \quad (15)$$

Where α and β are complex numbers that specify the probability amplitudes of the corresponding states. $|\alpha|^2$ and $|\beta|^2$ show the probability for a Q-bit to be in the “0” or “1” state, respectively. Hence, the states can be normalized to unity as follows:

$$|\alpha|^2 + |\beta|^2 = 1 \quad (16)$$

The Q-bit state is updated by using a quantum gate and can be represented as a unitary operator U. The types of quantum gates combines NOT, circulation and Hadamard gates(7). The circulation gate is utilized as (eqn.(17)) in the current study because many heuristic search algorithms have applied this gate[6,13,5,8].

$$U(\Delta\theta_i) = \begin{bmatrix} \cos(\Delta\theta_i) & -\sin(\Delta\theta_i) \\ \sin(\Delta\theta_i) & \cos(\Delta\theta_i) \end{bmatrix} \quad (17)$$

Where $\Delta\theta_i$, $i=1,2,3,\dots,n$ denotes the rotation angle of each Q-bit toward either the “1” or “0” state depending on the Q-bit sign.

Along these lines, pre-specified query tables are not required and the revolution edge can be detailed as pursues:

$$\Delta\theta_i = \theta \times (x_i + \beta_o e^{-\gamma r_{ij}^2} (x_j - x_i) + \alpha \text{rand}(\frac{1}{2})) \quad (18)$$

Where θ is the circulation angle magnitude along the iteration and decrease monotonously from θ_{max} to θ_{min} . The Q-bit individual string is then updated based on the circulation angle and circulation gate (eq.(19)). Finally the firefly’s position is updated based on the probability of $|\beta|^2$ by using eq.(20).

Table 2

Percent of fault occurrence in line with fault type.

Fault type	L-G fault	LL-G fault	LL-fault	LLL-fault
Occurrence percentage	74%	16%	5.5%	4.5%

Table 3

Fault quotes of various gadget elements.

System element	Bus fault per annum	Line fault per km per annum	Transformer fault per annum
Fault rate	0.08	4.5	0.015

$$\begin{bmatrix} \alpha_i(t+1) \\ \beta_i(t+1) \end{bmatrix} = U(\Delta\theta_i) \times \begin{bmatrix} \alpha_i(t) \\ \beta_i(t) \end{bmatrix} \quad (19)$$

$$x_i = \begin{cases} 1, & \text{if } |\beta_i(t+1)|^2 > r \\ 0, & \text{otherwise} \end{cases} \quad (20)$$

3.2 Objective capabilities and constraints

The purpose of the optimization is to determine a appropriate SR that may reduce N_{sag} and reliability indexes and enhance machine PQ and reliability without growing the entire line losses. Objective functions can be formulated to minimize the subsequent: (i) N (Eq. (21)), (ii) N sag and overall energy loss (P_{Loss}) (Eq. (22)), (iii) ASIFI (Eq. (23)), (iv) MAIFI (Eq. (24)), and (v) SAIFI (Eq. (25)) through optimization. these goal functions are expressed as given below:

$$\text{Fitness} = \min(N_{sag}) \quad (20 a)$$

$$\text{Fitness} = \min \left(\frac{N_{sag}}{N_{sag-max}} + \frac{P_{loss}}{P_{loss-max}} \right) \quad (20 b)$$

$$\text{Fitness} = \min(\text{ASIFI}) \quad (20 c)$$

$$\text{Fitness} = \min(\text{MAIFI}) \quad (20 d)$$

$$\text{Fitness} = \min(\text{SAIFI}) \quad (20 e)$$

Where, $N_{sag-max}$, $P_{loss-max}$ are the maximum number of sags and maximum power loss in the system. P_{loss} should additionally be within suitable limits in all cases except in Eq. (22).

Table: 4

Summarized PQ and reliability upgrades after NR whilst N_{sag} is the goal feature within the optimization.

System status	Because of weak area fault Healthy buses $V < 0.9$ pu	Because of weak area fault Sag exposed area %	System losses MW	System Sag index		System reliability indices		
				N_{sag}	Sag Index SARFI	SAIFI	ASIFI	MAIFI
Without SR	20	59.60	2	11570	2.56	19	55.07	4.33
After Optimal SR	43	9.66	1.99	4750	1.0	17.99	22	2.0
Overall performance	Improved 122.2%	Reduced 85 %	Raised to 15%	Reduced 140 %	Reduced 141%	Reduced 9%	Reduced 133%	Reduced 86%

Fig 4: 47 bus with bus no. versus power

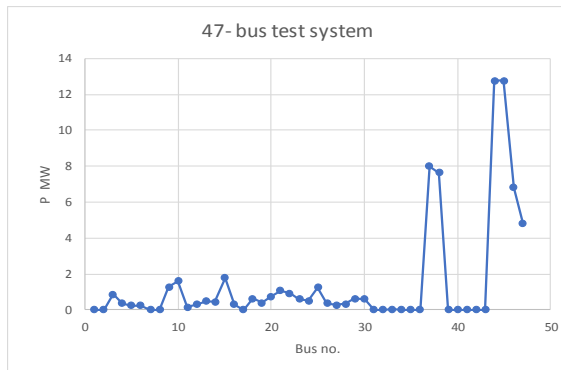

Fig 5: 47 bus with parameter settings

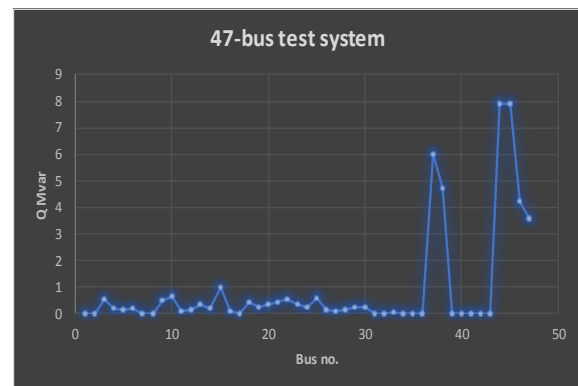

Table:5

BFA, BGSA and QBFA parameter settings.

Parameter	BFA	BGSA	QBFA
Population size	30	30	30
Max. iteration	30	30	30
G_0	-	100	-
Q_0	-	-	$\frac{1}{\sqrt{2}} + j\frac{1}{\sqrt{2}}$
$Kbest_{min}/\theta_{min}$	-	2.5%	0.001
$Kbest_{max}/\theta_{max}$	-	100%	0.05

3.3. QBFA implementation for optimal SR

On the basis of the goal capabilities and constraints indicated in phase three.4, reconfiguration may be carried out by using converting the predefined status of the tie and sectionalizing witches in the distribution network. N_{sag} , SARFI, ASIFI, MAIFI, SAIFI, and P_{loss} are calculated with the aid of using the quick circuit analysis and regular state load flow set of rules in MATLAB environment for every modification in community configuration. The implementation of the overall most desirable NR algorithm is specified inside the flowchart shown in Fig. 1.

3.4 Results and discussions

A sensible 47-bus distribution network is shown in Fig. 2 and is used to validate the proposed technique. The gadget includes forty-seven buses and forty-two branches furnished with the aid of a 132kV transmission device. 4 essential substations are related at Buses 2, 17, 34, and 39. Substation Buses 2 and 17 are fed via 132/11 kV and 30 MVA transformers, whereas Substation Buses 34 and 39 are fed by 132/33 kV and forty-five MVA transformers. Bus 1 is the swing bus. The seven tie switches between Buses 25 and 38, 29 and 38, 24 and 29, 16 and 18, four and 19, 20 and 23, and four and 14 may be used to alternate the gadget topology in case of surprising events or contingencies. The info of the machine bus are given in table 1.

4. Base case test results

Base case analyses, including load flow and fault analyses, are conducted to assess the

Light absorption coefficient(γ)	100	-	100
Initial randomization parameter (alpha, at t=1)	1	-	1

overall performance of the 47-bus distribution device previous to the gold standard NR. Fault evaluation simulations are performed on all buses, except for primary substations. P_{loss} , N_{sag} , SARFI, SAIFI, ASIFI, and MAIFI are 2.09, 11577, 2.97, 18.88, 55.07, and four.33, respectively (Table.5).

Table:6 Minimal fitness price. BGSA and BFA are slightly Open switches attributed to exceptional most useful NRs with numerous objective features.

System Status	Open Switches
Before Star	19-4, 14-4,16-18, 20-23,24-29,25-38,17-3,2-18,29-38
After Star with objective function, N_{sag}	2-18, 3-4,15-16, 17-26, 17-33,18-19,20-23,22-23,24-29
After Star with objective function $N_{sag} + P_{loss}$	2-18,3-4,16-18,17-26,17-33,18-19,20-23,24-25,24-29
After Star with objective function ASIFI	2-15, 2-18,3-4,17-26,17-33,18-19,20-23,24-25,24-29
After Star with objective function MAIFI	2-18,3-4,15-16,17-26,17-33,18-19,20-23,22-24,24-29
After Star with objective function SAIFI	2-18, 3-4,15-16,17-33,18-19,20-23,24-25,24-29,28-29

All 4 styles of fault simulations are conducted on all buses with voltage ranges underneath 33 kV, besides for the primary substations and buses supplied by multiple feeder, to decide the vulnerable region or the bus that reasons sag

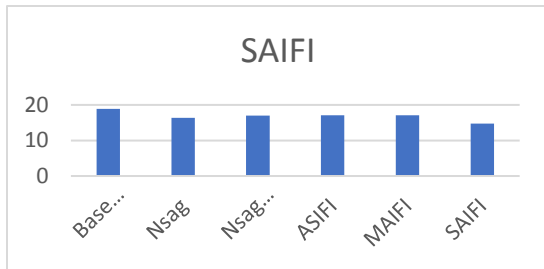

(a)

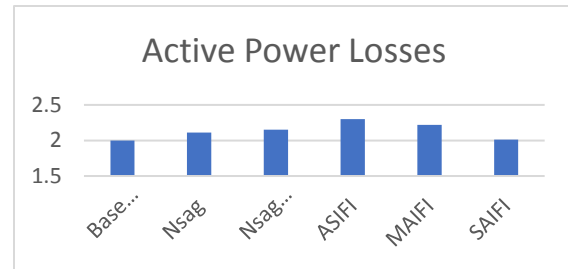

(b)

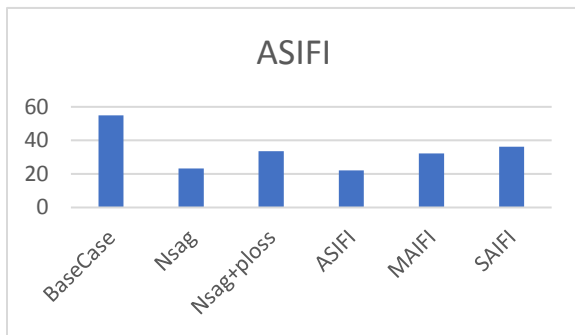

(c)

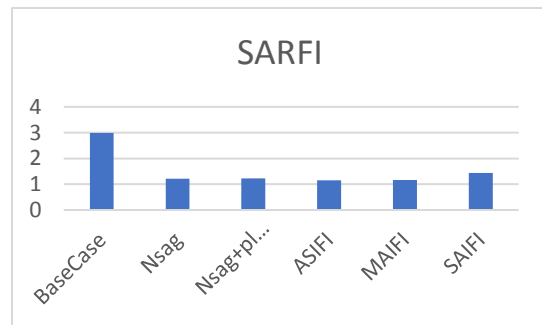

(d)

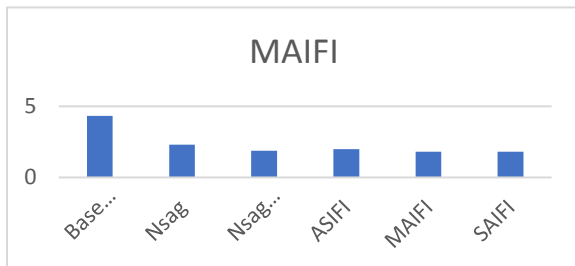

(e)

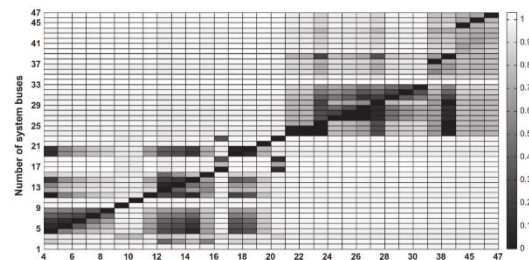

(f)

Fig: 6 Performance indicators of optimal SRs given various objective functions: (a) SAIFI

(b) Active losses (c) ASIFI (d) SARFI

(e) MAIFI (f) Voltage sag distribution of system

Buses attributed to LLL fault in all fault locations after optimal SR by QBFA when N_{sag} is objective function

propagation inside the gadget. All four sorts of fault simulations are carried out on all buses with voltage levels underneath 33 kV, except for the primary substations and buses supplied with the aid of more than one feeder, to decide the susceptible area or the bus that reasons sag propagation inside the gadget. The voltage levels at all machine buses given by way of the LLL fault with 0 fault resistance are proven in Fig. 3. touchy buses (vulnerable areas) which could affect PQ and reliability can be decided by way

4. SR OPTIMIZATION CONSEQUENCES

The desk underneath shows the important parameter settings for all optimization techniques used in this look at.

4.1. Evaluation with N because the goal characteristic:

Three optimization algorithms, specifically, QBFA, BGSA, and standard BFA, are used to formulate a unique best NR answer.

FA, BGSA, and fashionable BFA are as compared in phrases of convergence fee (the quantity of iterations required to converge), quality of the most excellent solution (fitness fee), and the time ate up by optimization The box plot corresponding to the fitness values indicates that QBFA performs higher than other algorithms because the 25th and seventy fifth percentiles of the QBFA samples lean closer to the minimum solution with a slim interquartile range. The suggest and median values of the QBFA are best, as indicated via the red line in Fig. 5, thus indicating that the chance of acquiring the

Acknowledgement:

References:

- [1] Aung MT, Milanovic JV, Gupta CP. Propagation of asymmetrical sags and the influence of boundary crossing lines on voltage sag

of looking at the darkish factors and the colour bar representing the voltage importance. Buses 19, 20, 22, 23, and 24 are the most sensitive to voltage sag propagation at some stage in the device, and Bus 22 influences maximum device buses. Fig. four indicates the machine voltage seasoned file throughout ordinary circumstance and the LLL fault at Bus characteristics inside the three optimization algorithms are depicted in Fig. 6

suitable answer is high in QBFA compared with other algorithms. The nice convergence

5. CONCLUSION

A novel premier NR technique with various objective capabilities is provided in this study to enhance the PQ and reliability of electric power distribution systems. FA is substantially improved with the aid of quantum idea integration and is used as an optimization device at some point of NR. The consequences acquired by the use of the proposed method are as compared with different well-known optimization algorithms for validation. The proposed QBFA is extra effective than BGSA and standard BFA. N is the most appropriate objective feature for PQ. However, the sag multi-objective characteristic, including N sag and P, is greater suitable than other goal functions if both PQ and reliability are equally critical. Gadget PQ index, SARFI, and reliability indexes (e.g., SAIFI, ASIFI, and MAIFI) can be significantly decreased via applying the proposed technique with the objective capabilities and QBFA. Loss

prediction. IEEE Trans Power Delivery 2004;19(4):1819–27.

- [2] Brooks DL, Dugan RC, Wacławski M, Sundaram A.

- Indices for assessing utility distribution system RMS variation performance. *IEEE Trans Power Delivery* 1998;13(1):254–9.
- [3] Chen SL, Chen GB, Hsu SC, Chen AYT, Guo TY, Huang FF, Huang YC. Mitigation of voltage sags by network reconfiguration of a utility power system. In: *Proceedings of the transmission and distribution conference and exhibition*. Yokohama, Japan: IEEE Press; 2002. p. 2067–72.
- [4] Civanlar S, Grainger JJ, Yin H, Lee SSH. Distribution feeder reconfiguration for loss reduction. *IEEE Trans Power Delivery* 1988;3(3):1217–23.
- [5] Chou YH, Chiu CH, Yang YJ. Quantum-inspired tabu search algorithm for solving 0/1 knapsack problems. In: *Proceedings of the 13th annual conference companion on genetic and evolutionary computation*. Dublin, Ireland: ACM; 2011. p. 55–6.
- [6] Han KH, Kim JH. Quantum inspired evolutionary algorithm for a class of combinatorial optimization. *IEEE Trans Evol Comput* 2002;6:580–93.
- [7] M. H. Ali, T. Murata, T. Tamura, "Minimization of Fluctuation of Line Power and Terminal Voltage of Wind Generator by Fuzzy Logic-Controlled SMES," *IEEE*, vol. 1, no. 4, pp. 559-566, Oct. 2006.
- [8] Tomoki Asao, Rion Takahashi "Smoothing Control of Wind Power Generator Output by Superconducting Magnetic Energy Storage System", *Proceeding of International Conference on Electrical Machines and Systems*, pp. 302-307, 2007.
- [9] Young-Tack Seo, Sang-Jin Kwan, "Influence of Grid Operation from Ullung Wind Power Plant" *ETRI Journal*, Vol.22, 2001.
- [10] *RSCAD/RTDS Manual*: RTDS Technologies Inc., 2005
- [11] *PSCAD/EMTDC Power Systems Simulation Manual*: Manitoba HVDC Research Centre, 1995