

# AN ADVANCED IMPLEMENTATION OF THE VOLTAGE LEVEL MONITORING AND CONTROL USING SOFT SENSOR METHODS FOR UNIFIED POWER QUALITY CONDITIONER

**P. MadhavaSarma**  
Professor, Dept. of ECE,  
Saraswathy College of Engg. &  
Tech, Tindivanam, India  
spms1975@yahoo.co.in

**S. Arulkumar**  
Research Scholar,  
Dept. of EEE,  
Anna University, Chennai, India  
arulkumar.ssam@gmail.com

**M. Sridevi**  
Asso.Prof, Dept. of EEE,  
Agni College of Technology,  
Chennai, India  
sridevicognizant@gmail.com

**P. Veeraragavan**  
Assistant Professor, Department of Physics,  
University College of Engineering, Anna University,  
Chennai, Tindivanam,  
veeraucet@gmail.com

**Srinivasan Alavandar**  
Professor, Dept. of EEE,  
Agni College of Technology,  
Chennai, India  
seenu.phd@gmail.com

**Abstract:** *This paper presents a design and simulation of UPQC system for limitations of nonlinear load factors. The Neural Network controller is designed for tuning the PI controller parameters for achieving the optimal voltage in the solar power connected to the UPQC system. Solar power used to improve the power for load side power system designed in network. The MATLAB simulation software is used for simulation of results. From the simulation results, the Total Harmonics Distortion value is reduced from 2.77% to 1.04% in the voltage side similarly 4.48% to 1.54% in the current side. Also the waveform of the supply system is improved.*

**Key Words:** *UPQC, Power Quality, PI, Fuzzy controller, Particle Swarm Optimization.*

## 1. Introduction

The power factor stability and quality is distributed due to various factor such as sag voltage, non linear load etc. For the power system engineer controlling and maintaining the quality of power factor in the desired level is the challenging task. For maintaining the voltage and current level in the constant value during the operation time will be tedious because of variation of load side voltage and power line loss etc. Recent times for power quality improvement purposed the following authors Kolhatar and Das have explained the detailed concept of UPQC involved in the uninterrupted power supply (UPS) [1].

Aredes et al. has proposed the dynamic voltage restorer (DVR) which is connected together via common link capacitor. In which showing of the active power concept is assigned in detailed [2]. Singh.A et al has explained the power quality problem in the transmission lines [3]. Ghosh et al.

briefed about topology methods used in feeder in the network system. In critical load bus regulation of voltage is the important parameter. It has been clearly explained it [4]. Khadkikar et al. have elaborated the compensation of voltage and current adjacent feeders [5]. Fujita et al. has identified the unified power quality conditioner for current condition purpose [6].

Karimi et al. has explained the rotating reference frame used for suppress the harmonics and important of power factor problems [7]. George has explained the soft computing based controller [8]. Basu et al. has proposed new methods for generating gating signal for current regulation in a shunt converter [9]. Zhili et al. have proposed protection methods for voltage surges, various short circuit condition in the UPQC system [10]. Axete et al. have proposed effect of harmonics in the transformer and LC filter and they have also discussed about inverter side harmonics problems [11].

This paper discussed about without series injection transformer UPQC system is connected the distributed side connection for medium voltage application [12]. Neural network based controller employed in the UPQC system which gives good result for electronics application. The paper deals with monitoring stability in the UPQC system using neural network methods [13]. The authors have elaborated the application of NN in this paper, which was clearly discussed about configuration and tuning rules etc. Fuzzy logic controller plays critical rule in this work. The paper discussed about the compensation signal to CSI cased system [14-18].

Recent time improvement of neural network is given in the wing rock system. This SRFNNC system is comprised of a recurrent fuzzy neural network (RFNN) controller and a supervisory controller [19]. To improve control accuracy and

robustness to disturbances and noise, new design strategies are necessary to overcome problems caused by nonlinearity and mutual interactions [20]. In steel roll mill have the neural network controller is employed in elaborated in this work [21]. The authors have clearly compared the performance of the different controller and have been listed in this paper [22]. For important of cross-width profile thickness in the hot rolling mill ANN controller has been implemented for controlling [23].

In this work, the conventional PI controller has been replaced by a ANN controller (ANNC). The ANNC has been used in APFs in place of conventional PI controller for improving the dynamic performance [24, 25].

The power electronics applications for control purpose ANN was used for self-adapting and high-rated calculation for handle high nonlinearities, uncertainties susceptible to occur in a controlled nonlinear system [26]. Control of shunt and series active power filter s simple feed forward ANN has been used [27]. Control methods, such as the PI, PID, sliding-mode, predictive, unified constant frequency (UCF) controllers, etc., was implemented [28-30]. In this paper Neural Network based PI tuned power quality improvement system is implemented.

## 2. Measurement methods

The schematic diagram of UPQC and solar system is shown in Fig. 1. The AC supply which is connected to the series transformer whose output is given to filter. The filtered AC output is given to series and shunt inverter. For maintaining the harmonic level and rectification of ripple factor DC capacitor line is connected. For maintaining the voltage level of the DC capacitor line different control strategies has been implemented.

## 3. PI controller

The schematic block diagram of PI controller is shown in Fig. 2. The input voltage is the set up by the user. The output value is taken from the UPQC system feedback to comparator.

The comparator compares the both input and output value. The output of the comparator is gives to proportional integral controller. The function of PI controller is to reduce the overshoot value in the system voltage and maintaining a constant load voltage level. Normally the tuning value of PI controller set is using Z-N tuning method. In this work the controller tuning value  $K_p=1.6$  and  $\tau_i=36$ .

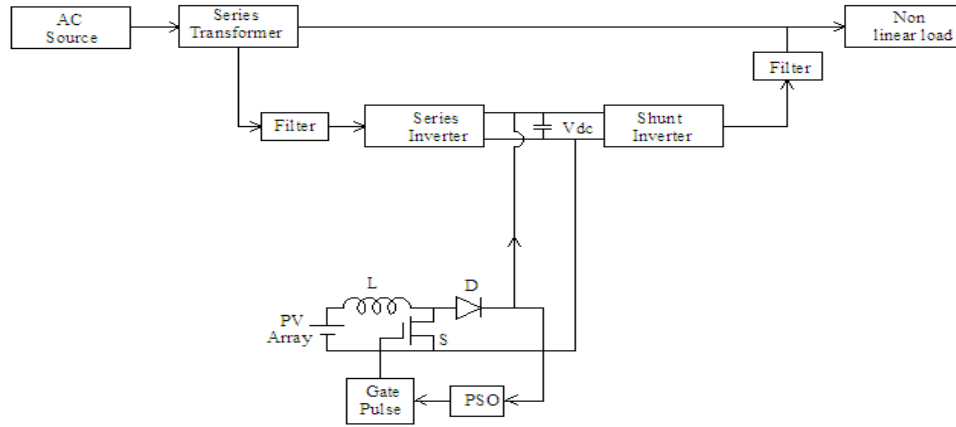

Fig. 1. Configuration of UPQC and solar system

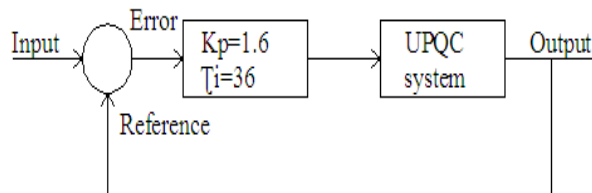

Fig. 2. Schematic block diagram for PI controller

#### 4. Design of fuzzy logic controller

Fuzzy logic controller schematic block diagram is shown in Figure 3. It has four blocks; first block is fuzzification which is used to convert the crisp information into Fuzzy value. Fuzzy logic system scaling is the important criteria, which is used for correct the input and output range of the system. In this fuzzy system input and output range value are desired and it has been named as input variable and output variable respectively.

The rule base is also designed for the decision made execution of action by assigning strategies to the rules is made. All the rules are controlled and the output is defuzzified. In this paper Fuzzy logic controller is designed using two input variables Error (E) and Changing Error (CE) are feed to the fuzzy controller. Each of the variables having 7 membership functions which is labeled NB (negativebig), NM (negativemedium), NS (negativesmall), ZE (zero), PS (positivesmall), PM (positivemedium), and PB (positivebig), Table 1. Depicts the 49 control rules are developed for this UPQC system using Error (E) and Changing Error

(CE) as input variables. Finally the 49 sets are defuzzified in to a single value.

#### 5. Designing and training of ANN

An ANN is essentially a cluster of suitably interconnected non-linear elements of very simple form that possess the ability of learning and adaptation. These networks are characterized by their topology, the way in which they communicate with their environment, the manner in which they are trained and their ability to process information. Their ease of use, inherent reliability and fault tolerance has made ANNs available medium for control. An alternative to fuzzy controllers in many cases, neural controllers share the need to replace hard controllers with intelligent controllers in order to increase control quality (King, 1999).

A feed forward neural network works as compensation signal generator. This network is designed with three layers. The input layer with seven neurons, hidden layer with 21 and the output layer with three neurons are given. Activation functions chosen are tan sigmoidal and pure linear in the hidden and output layers respectively. The network topology of ANN is as shown in Fig. 4.

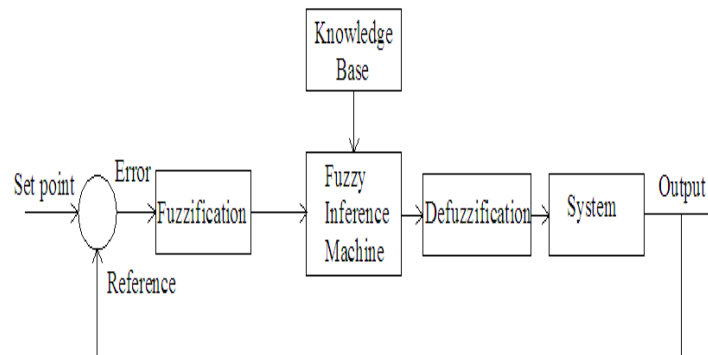

Fig. 3. Schematic block diagram for Fuzzy logic controller

Table 1. Rule base of the DC voltage control

		ERROR (E)						
		NL	NM	NS	EZ	PM	PS	PL
CHANGING ERROR (CE)	NL	NL	NL	NL	NL	NM	NS	EZ
	NM	NL	NL	NL	NM	NS	EZ	PS
	NS	NL	NL	NM	NS	EZ	PS	PM
	EZ	NL	NM	NS	EZ	PS	PM	PL
	PM	NM	NS	EZ	PS	PM	PL	PL
	PS	NS	EZ	PS	PM	PL	PL	PL
	PL	EZ	PS	PM	PL	PL	PL	PL

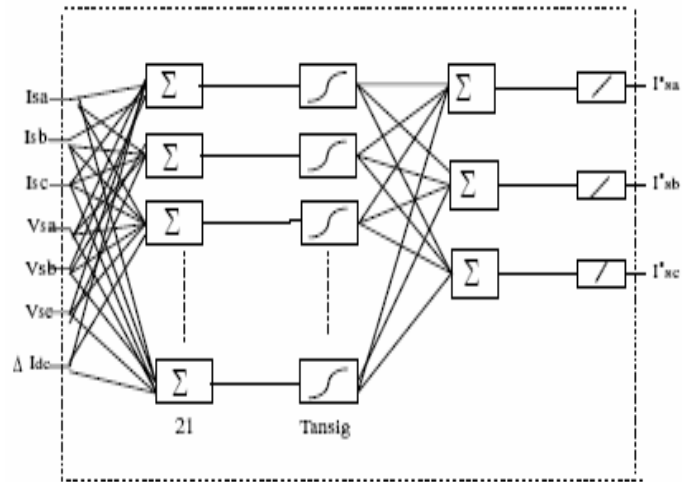

Fig. 4. Exploded diagram of ANN

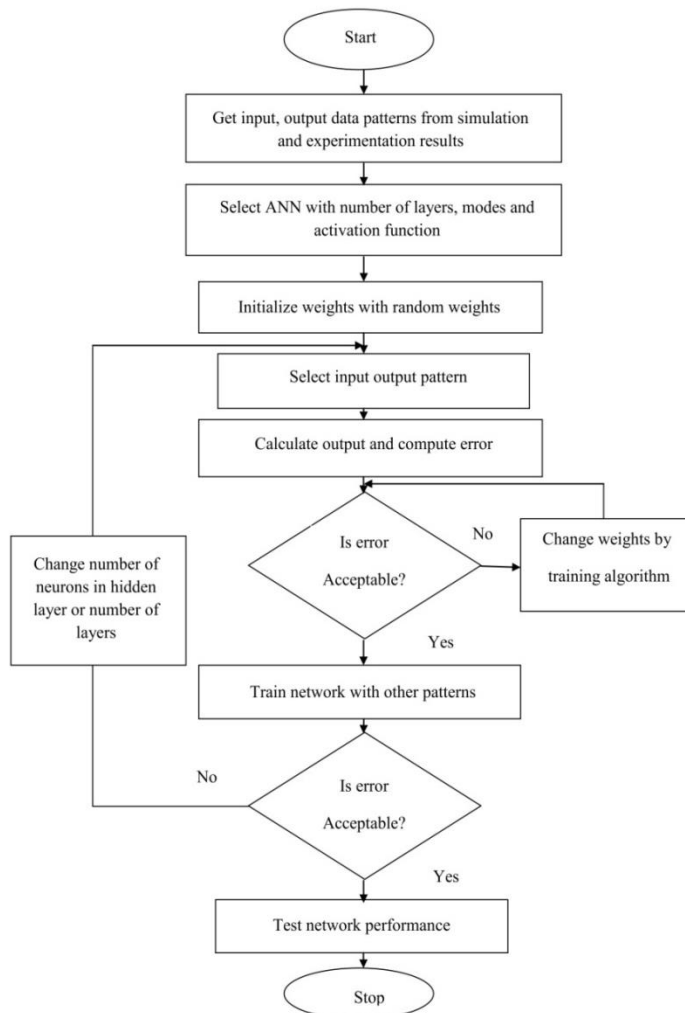

Fig. 5. Flow chart for training ANN controller

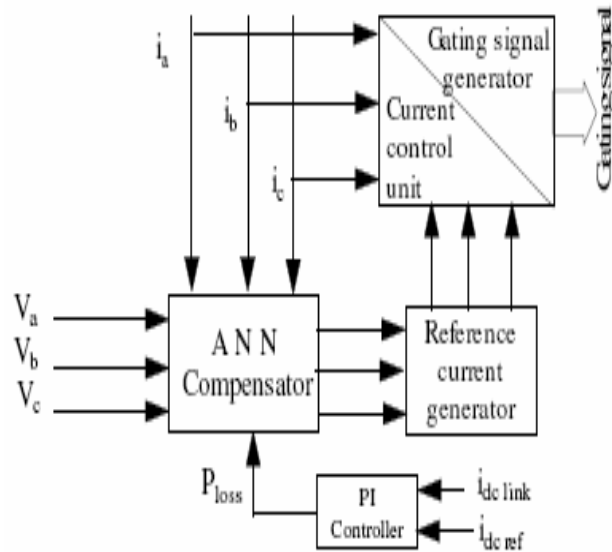

Fig. 6. Block diagram of ANN-based system

The compensator output depends on input and its evolution. The chosen configuration has seven inputs three each for reference load voltage and source current respectively, and one for output of error (PI) controller. The neural network trained for outputting fundamental reference currents. The signals thus obtained are compared in a hysteresis band current controller to give switching signals. The block diagram of ANN compensator is as shown in Fig. 6.

Neural network has generated a good deal of interest in certain applications. Studies show that artificial neural networks (ANN) are reliable in improvement of power electronic system control, in fact self-adapting and high-rated calculation characteristics of ANN allows them to handle high

nonlinearities, uncertainties susceptible to occur in a controlled nonlinear system (Elmitwally et al., 2000).

## 6. Membership function distribution

Initially the fuzzy PI controller is developed for the conventional PI controller. Afterwards fuzzification, rule base and defuzzification for the decision of the fuzzy logic are discussed. The decision involves the fixing the membership function to the parameter such as Error (E), Changing Error (CE) and output. The membership function is shown in figure 7 and the range of membership value 0, 1.2 for error and change of error is -1, 1 and similarly the controller output range is 0, 1 and shown in Fig. 8 and Fig. 9 respectively.

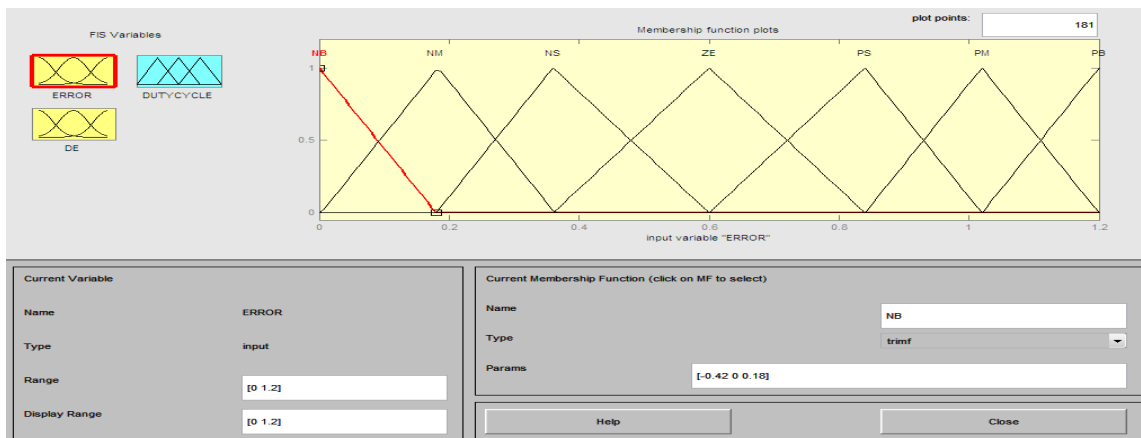

Fig. 7. Error (E)

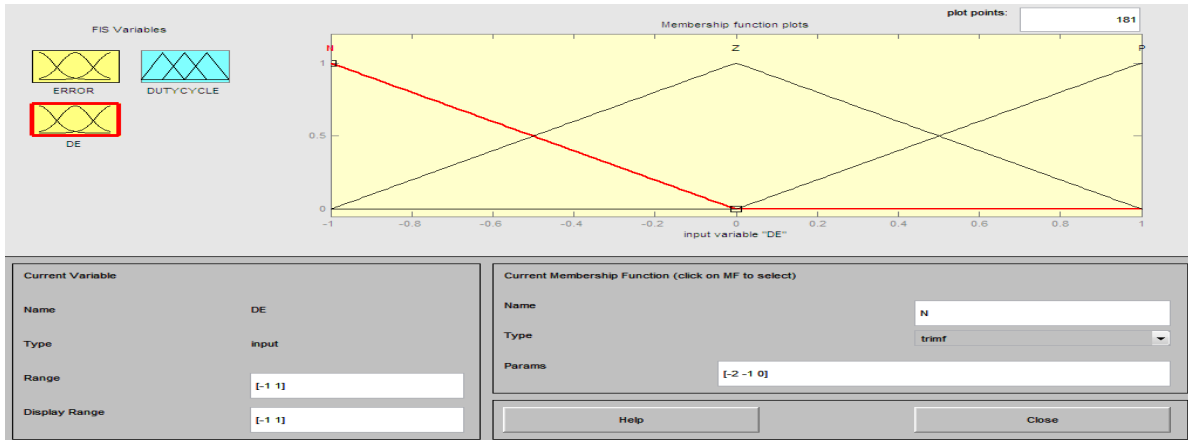

Fig. 8. Changing Error (CE)

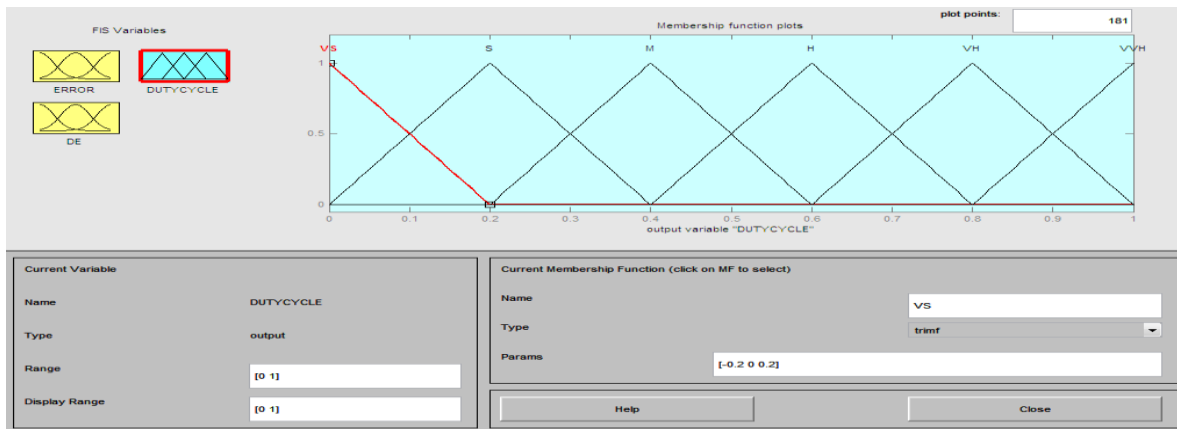

Fig. 9. Controlled output

## 7. Result and discussion

### (i) Output response PI controller

In this PI controller the source voltage is given to UPQC system is  $V_{rms}=1.1 \times 10^4$  V and current is  $I_{rms}=12$  Ampere. PI controller output response for source voltage side is shown in Figure 10. It is inferred from the Figure 10 the input voltage is  $V_{rms}=1.1 \times 10^4$  volts for all the phases and the current  $I_{rms}$  is for phase-A 12.72A, phase-B 12.73 A and phase-C 12.76 A. From the Fig. 11 the PI controller output response for load voltage and current. It is observed that the PI controller

maintaining the load voltage is  $V_{rms}=1.098 \times 10^4$  from Fig. 12 and the current is same for all the phases  $I_{rms}=15.55$  A from Fig. 13. PI controller output responses for real and reactive power for source side and load side is shown in Fig. 14 and Fig. 15. In this Figure the real and reactive power is significantly improved the value of  $P_{load}=5391$  and  $Q_{load}=5757$  similarly from source side real and reactive power  $P_{source}=3384$  and  $Q_{source}=-4442$ . In addition to the about the Harmonic distortion level is more for PI controller. Hence for the purpose assign Fuzzy logic controller can be implemented.

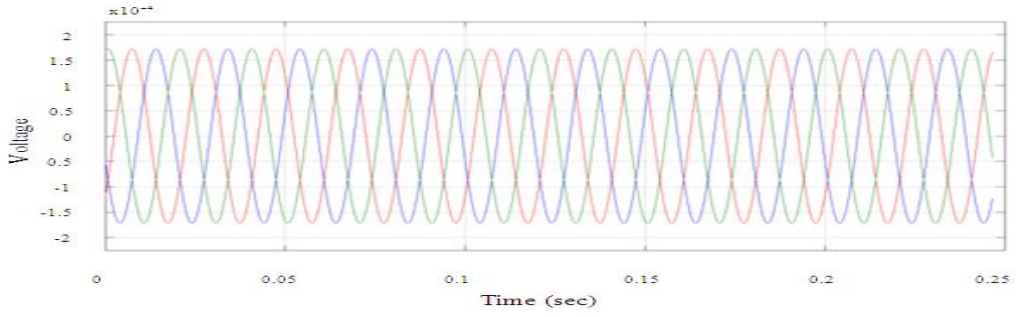

Fig.10 Waveform for source voltage and current (PI controller)

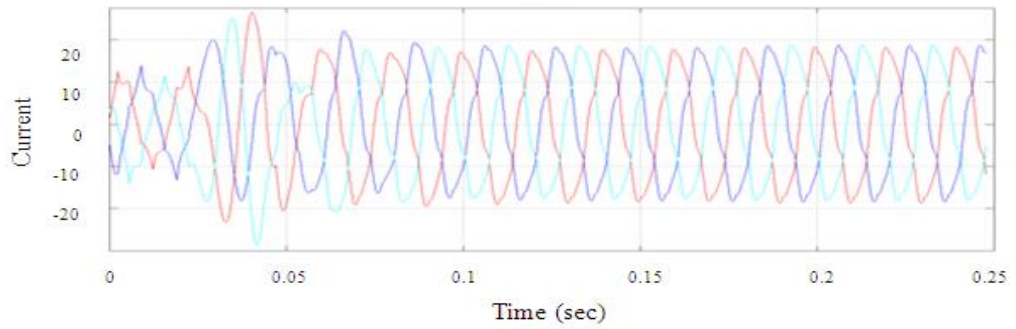

Fig.11 Waveform for source voltage and current (PI controller)

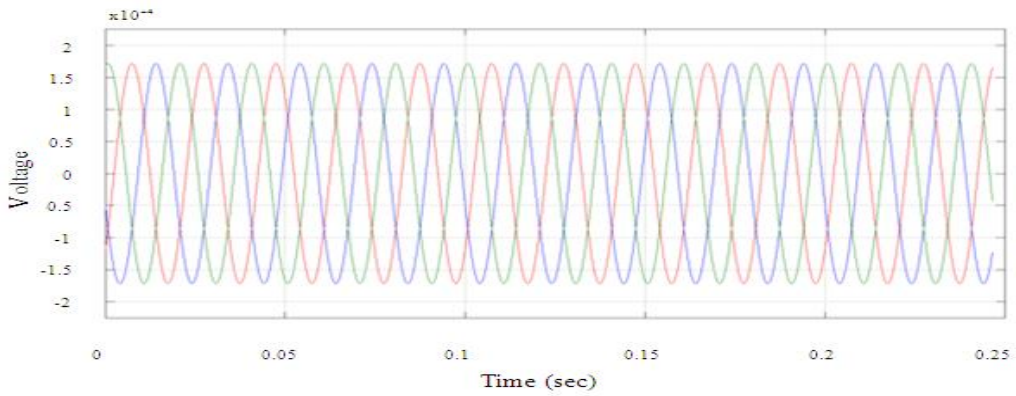

Fig.12 Waveform for load voltage and current (PI controller)

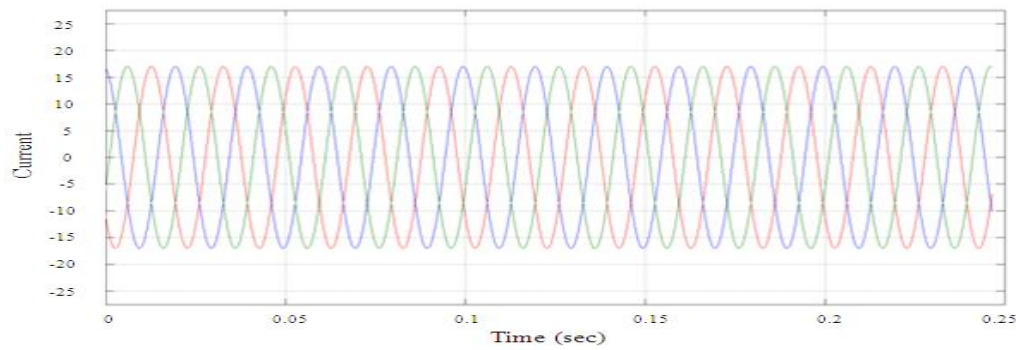

Fig.13 Waveform for load voltage and current (PI controller)

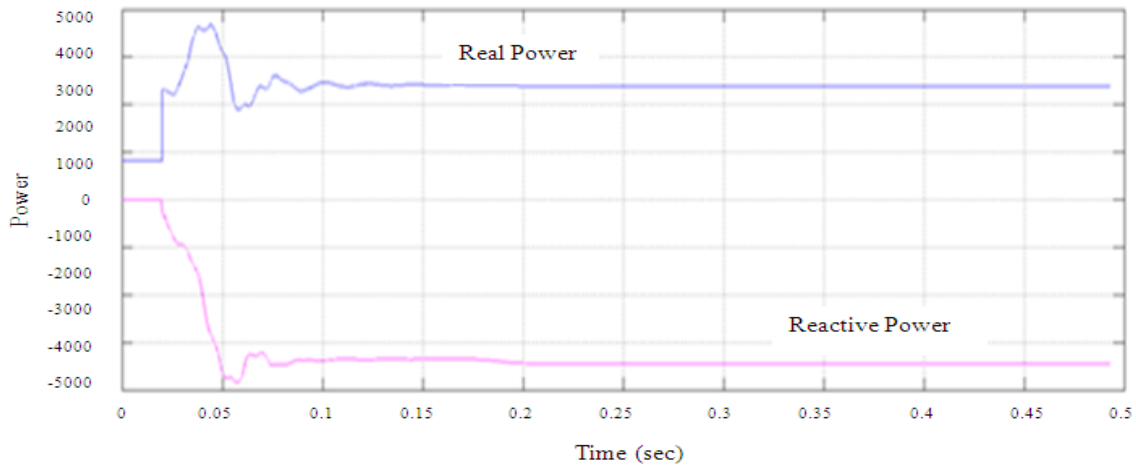

Fig.14 Waveform for real and reactive power for source side and load side (PI controller)

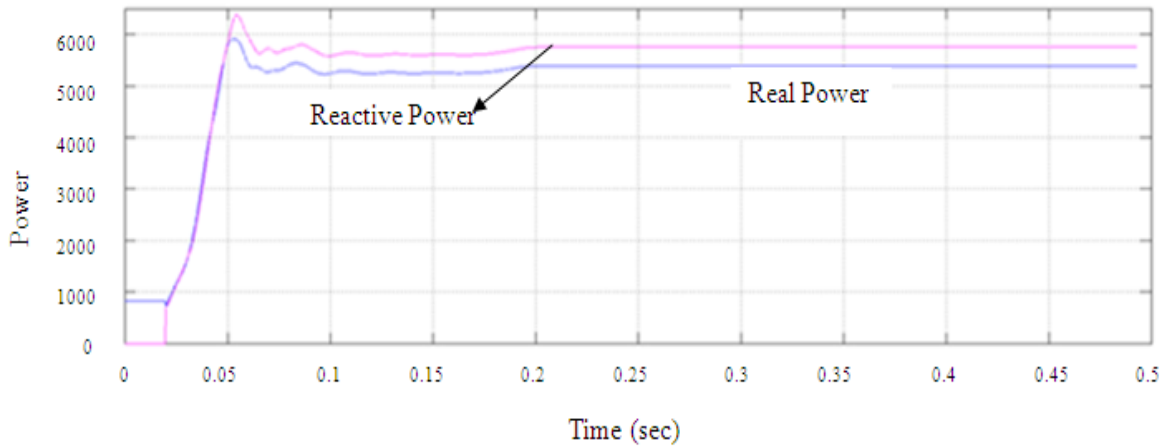

Fig.15 Waveform for real and reactive power for source side and load side (PI controller)

### (ii) Fuzzy controller output response

Fuzzy logic controller is designed for the controlling the voltage and current level in the UPQC system. The membership function was written and all the values are entered in the fuzzy controller. After obtaining the proper tuning value the fuzzy based PI controller output response is shown in Fig. 16 to Fig. 21. The extracted response from the source side voltage and current waveforms has shown in Figure 16 and 17 respectively.

The source side voltage waveform from in this work the input voltage is  $V_{rms}=1.1 \times 10^4$  for all

the phases and the current  $I_{rms}$  is for phase-A 594.2 A, phase-B 620.9 A and phase-C 592.9 A. Load side voltage and current waveform is shown in Fig. 18 and Fig. 19. From the Fig. 18 structure load voltage is maintained constant  $V_{rms}=1.098 \times 10^4$  and from Fig. 19 the current is same for all the phases  $I_{rms}=547.1$  A. Fig. 21 shows the waveform of load side real and reactive power is improved  $P_{load}=14.3 \times 10^4$  and  $Q_{load}=8.1 \times 10^4$  from source side real and reactive power  $P_{source}=11.2 \times 10^4$  and  $Q_{source}=13.8 \times 10^4$  as shown in Fig. 20. When compare to PI controller based UPQC system, the Fuzzy based PI controller is superior.



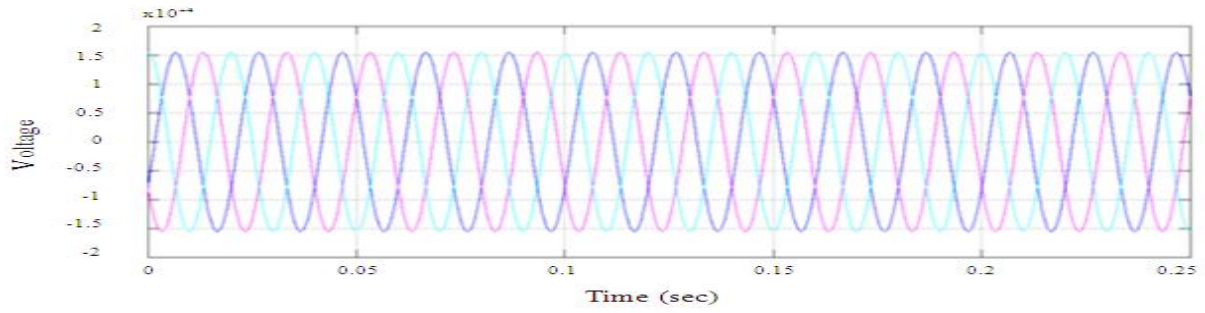

Fig. 16. Waveform for source voltage and current (with Fuzzy controller)

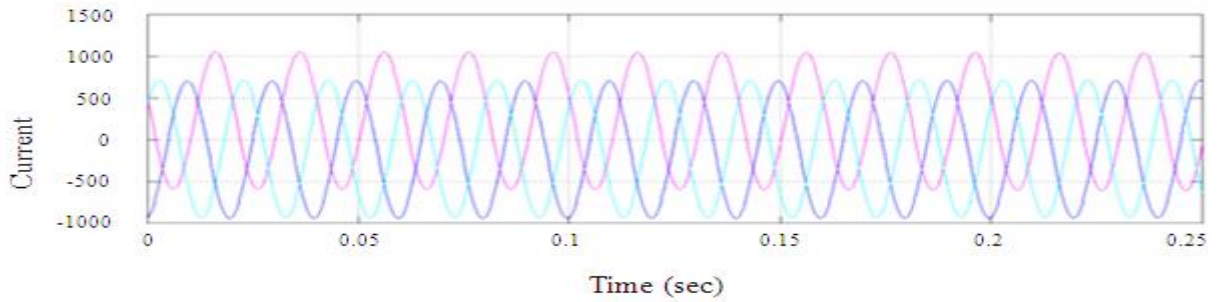

Fig. 17. Waveform for source voltage and current (with Fuzzy controller)

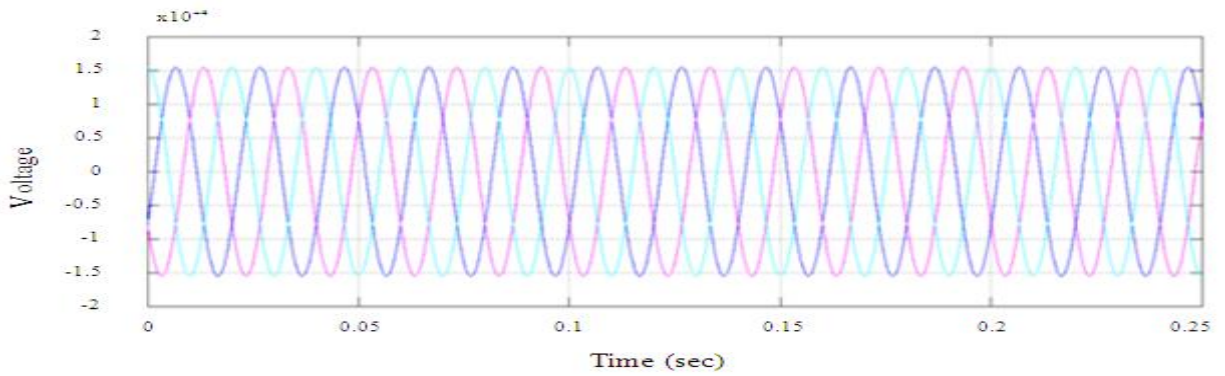

Fig. 18. Waveform for load voltage and current (with Fuzzy controller)

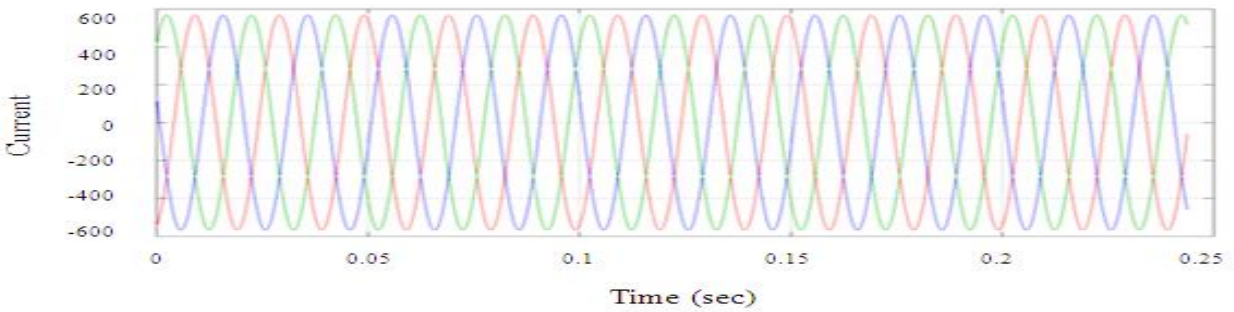

Fig. 19. Waveform for load voltage and current (with Fuzzy controller)

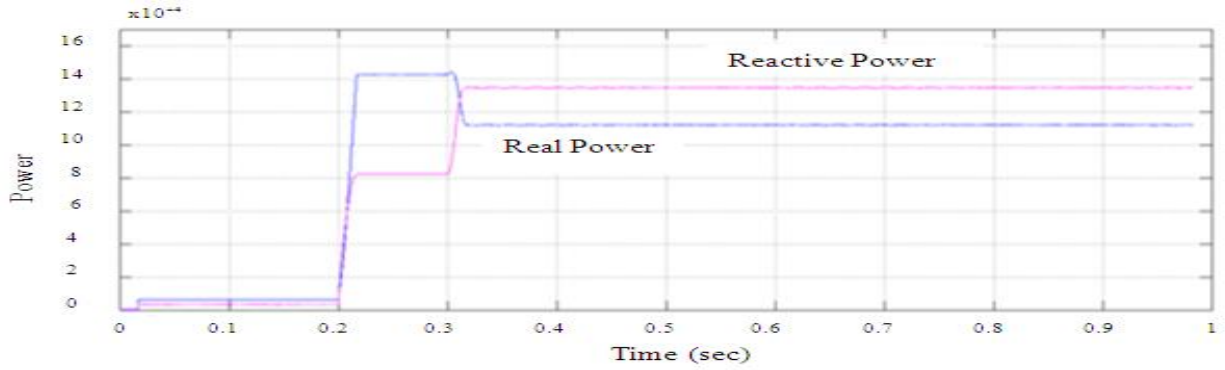

Fig. 20. Waveform for real and reactive power for source side and load side (with Fuzzy controller)

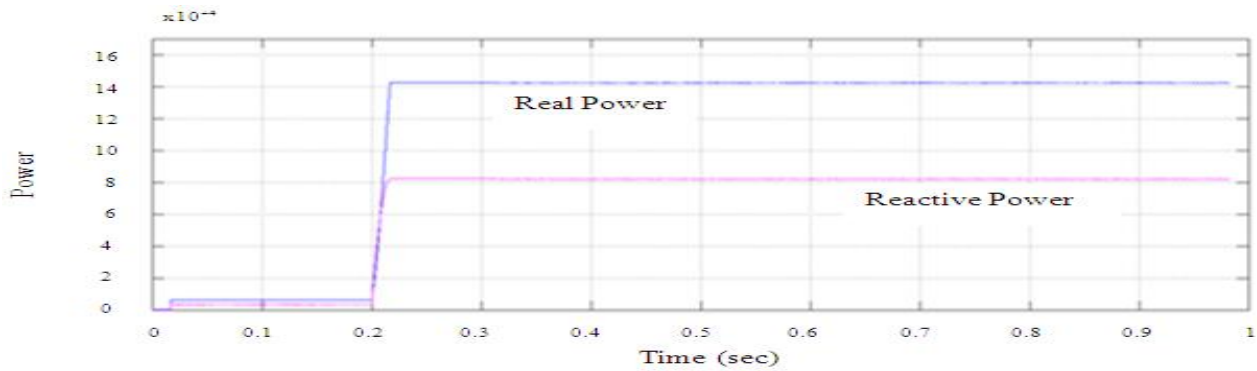

Fig.21 Waveform for real and reactive power for source side and load side (with Fuzzy controller)

**(ii) Neural Network controller output response**

After introducing the Neural Network controller, the response is shown in Fig. 22 to Figure27. The source side voltage waveform from shown in the Figure22, the input voltage is  $V_{rms}=1.098 \times 10^4$  for all the phases and the current  $I_{rms}$  is for phase-A 618.4 A, phase-B 645.7 A and phase-C 617 A as shown in Figure23. From the Fig. 24 structure load voltage is maintained constant

$V_{rms}=1.098 \times 10^4$  and the current is same for all the phases  $I_{rms}=573.3$  A shown in Fig. 25. The Fig. 27 shows the waveform of load side real and reactive power is improved  $P_{load}=17.8 \times 10^4$  and  $Q_{load}=3.9 \times 10^4$  from source side real and reactive power  $P_{source}=12.2 \times 10^4$  and  $Q_{source}=14.8 \times 10^4$  as shown in Fig. 26. It was inferred NN is superior to Fuzzy logic controller.

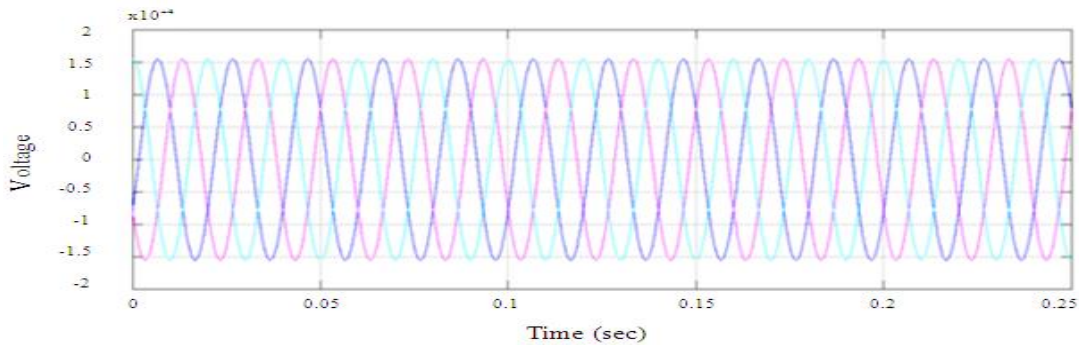

Fig. 22. Waveform for source voltage and current (with NN controller)

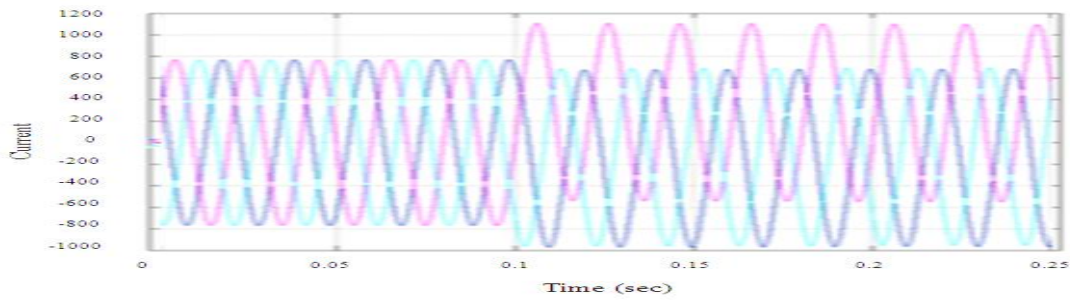

Fig. 23. Waveform for source voltage and current (with NN controller)

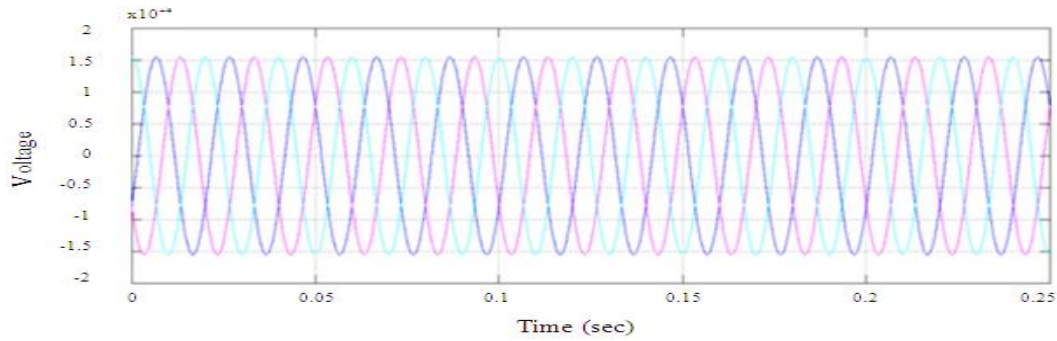

Fig. 24. Waveform for load voltage and current (with NN controller)

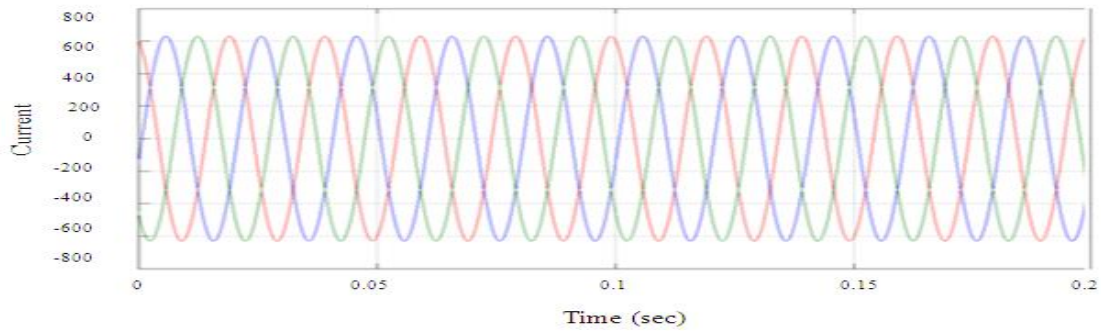

Fig. 25. Waveform for load voltage and current (with NN controller)

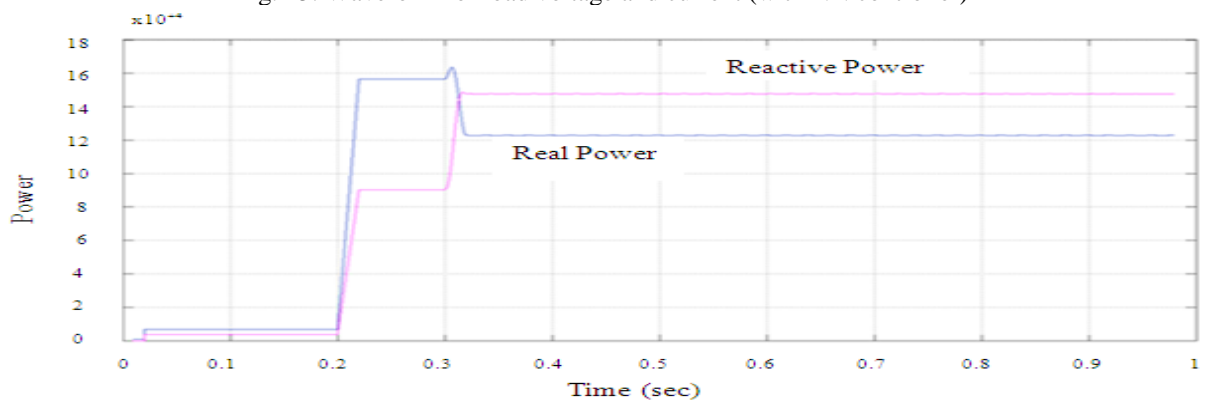

Fig. 26. Waveform for real and reactive power for source side and load side (with NN controller)

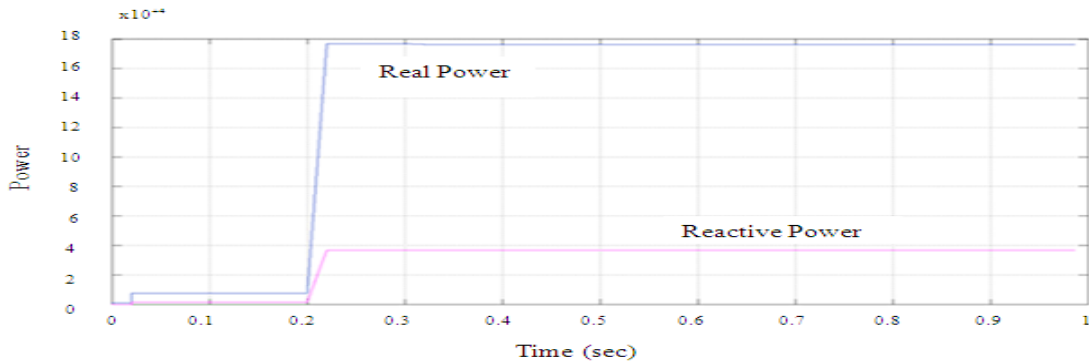

Fig. 27. Waveform for real and reactive power for source side and load side (with NN controller)

Table 2. Comparison of Harmonics result with different controller

S.NO	Controller	THD for Voltage Harmonics (%)			THD for Current Harmonics (%)		
		Phase A	Phase B	Phase C	Phase A	Phase B	Phase C
1	Without controller	13.22	13.71	13.50	15.91	15.02	15.52
2	PI	3.01	2.33	2.98	4.86	4.02	4.56
3	Fuzzy	1.11	1.29	1.07	2.02	2.48	1.56
4	Neural Network	1.02	1.07	1.03	1.50	2.10	1.04

## 8. Conclusion

Neural Network based PI tuned controller is designed for maintaining the voltage level constant in the UPQC system and to improve the power quality. It is observed from the Table 2. Neural Network tuned PI controller is best suited for this system.

## References

- [1] Kolhatkar, Y. and Das, S.P. "Experimental investigation of a singlephase UPQC with minimum VA loading", IEEE Trans. Power Del., Vol. 22, No. 1, pp. 373–380, 2007.
- [2] Aredes, M. and Heumann, K. "An universal active power line conditioner," IEEE Trans. Power Del., Vol. 13, No. 2, pp.545–551, 1998.
- [3] Singh, A. and Kamal, R. "A Review of Active Filters for PowerQuality Improvement", IEEE Trans on Industrial Electronics, Vol.46,No.5,pp. 960-970. 1999.
- [4] Ghosh, A. and Joshi, A. "A unified power quality conditioner for voltage regulation of critical load bus," in Proc. IEEE Power Eng. Society General Meeting, Vol.1, No.5, pp. 471-476, 2004.
- [5] Khadkikar, V. "Enhancing Electric Power Quality Using UPQC: A Comprehensive Overview", IEEE Trans on Power Electronics, Vol. 27, No. 5, pp. 522–531, 2012.
- [6] Fujita, H. and Akagi, H. "The unified power quality conditioner: The integration of series and shunt active filters", IEEE Trans. Power Electron. Vol.13, No. 2, pp. 315–322, 1998.
- [7] Karimi, K., Ghartemani, M., Iravani, R. and Bakhshai, A. "An adaptive filter for synchronous extraction of harmonics and distortions", IEEE Trans. Power Del., Vol. 18, No. 4, pp. 1350–1356, 2003.
- [8] George, M. "Artificial intelligence based three-phase unified power quality conditioner," J. Comput.Sci., Vol. 3, No. 2, pp. 465–477, 2007.
- [9] Basu, M. Das, S.P. and Dubey, G.K. "Investigation on the performance of UPQC-Q for voltage sag mitigation and power quality improvement at a critical load point," Inst. Eng. Technol. Gen. Transm. Distrib. Vol.2, No. 2, pp. 414–423, 2008.
- [10] Zhili, T and Dongjiao, Z. "Design of dc voltage controller for UPQC by using its small signal model,"

Proc. Electr. Control Eng., Vol.11, No.4, pp. 3572–3575, 2010.

[11] Axente, N. and Jayanti, G. “A 12 kVA DSP controlled laboratory prototype UPQC capable of mitigating unbalance in source voltage and load current,” IEEE Trans. Power Electron., Vol. 25, No. 6, pp.1471–1479, 2010.

[12] Han, B., Baek, S. and Jang, G. “New configuration of UPQC for medium-voltage application,” IEEE Trans. Power Del., Vol. 21, No. 3, pp. 1438–1444, 2006.

[13] A. Zouidi, F. Fnaiech, and K. AL-Haddad—Neural network controlled three-phase three-wire shunt active power filter, in Proc. IEEE ISIE, Montreal, QC, Canada, Jul. 9–12, 2006, pp.5–10.

[14] R. El Shatshat, M. M. A. Salama, and M. Kazerani, —Artificial intelligent controller for current source converter-based modular active power filters, IEEE Trans. Power Del., vol. 19 no. 3, pp. 1314–1320, Jul. 2004.

[15] J. R. Vazquez and P. R. Salmer “Three-phase active power filter control using neural networks, in Proc. 10th Mediterranean Electro Technical Conf., 2000, vol. III, pp. 924–927.

[16] A. Elmitwally, S. Abdelkader, and M. EL-Kateb, Neural network controlled three-phase four wire shunt active power filter Proc. Inst. Elect. Eng., Gen. Transm. Distrib., vol.147, no. 2, Mar. 2000.

[17] R V D Rama Rao ,Subhransu Sekhar Dash “Enhancement of Power Quality by using Unified Power Quality Conditioner with PID and Fuzzy Logic Controller” International Journal of Computer Applications (0975 – 8887) Volume 5– No.7, August 2010.

[18] Rahul Suryavanshi, Diwakar R. Joshi, Suresh H. Jangamshetti, ”PSO and P&O based MPPT Technique for SPV Panel under Varying Atmospheric Conditions” International Journal of Engineering and Innovative Technology (IJEIT), Volume 1, Issue 3, March 2012.

[19] C.-M. Lin and -F. Hsu, “Supervisory recurrent fuzzy neural network control of wing rock for slender delta wings,” IEEE Trans. Fuzzy Systems, vol.12, pp.733-742, 2004.

[20] Y. Frayman and L.P. Wang, “A dynamically-constructed fuzzy neural controller for direct model reference adaptive control of multi-input-multi-output nonlinear processes” Soft Computing, vol.6, pp.244-253, 2002.

[21] D. Sbarbaro-Hofer, D. Neumerkel, and K. Hunt, “Neural control of a steel rolling mill,” IEEE Control Systems Magazine, Volume 13, pp.69-75, June 1993.

[22] L.P. Wang and Y. Frayman, “A dynamically generated fuzzy neural network and its application to torsional vibration control of tandem cold rolling mill spindles”, Engineering Applications of Artificial Intelligence, vol. 15, no. 6, pp. 541-550, December, 2002.

[23] L.M. Pedersen and B. Wittenmark, “Multivariable controller design for a hot rolling mill,” IEEE Trans. Control Systems Technology, Vol. 6, pp.304-312, March 1998

[24] Saerens M., Soquet A., “Neural Controller based on back propagation algorithm” IEE proceeding F, vol. 138, no. 1, 1991, p. 55-62.

[25] Hagan M., Demuth H., “Neural network Design, Boston” PWS, 1996

[26] Elmitwally, A., Abdelkader, S. and EL-Kateb, M. ‘Neural network controlled three-phase four-wire shunt active power filter’, IEE Proc.-Gener. Trans. Distr., March, Vol. 147, No. 2, 2000.

[27] Zouidi, A., Fnaiech, F. and AL-Haddad, K. (2006) ‘Neural network controlled three-phase three-wire shunt active power filter’, Proceedings of IEEE ISIE, July 9–12, Montreal Quebec, Canada, pp.5–10.

[28] V. S. C. Raviraj and P. C. Sen, ‘Comparative study of proportional integral, sliding mode and fuzzy logic control for power converters’, IEEE Trans. Ind. Appl., vol. 33, no. 2, pp. 518–524, March/April. 1997.

[29] J. H. Marks and T. C. Green, ‘Predictive control of active filters’, in Proc. Inst. Elect. Eng. Conf. Power Electron and Variable Speed Drives, September. 2000, pp. 18–23.

[30] Y. Chen, L. F. Sanchez, K. M. Smedley, and G. Chen, One-cycle controlled unified power quality conditioner load side voltage sag compensation, in Proc. Power Electronics Specialists Conf., 2005, vol. 36, pp. 282–288.