

Tom 55(69), Fascicola 1, 2010

STRUCTURE CALCULATION FOR THE CONCRETE BRIDGE OVER THE RUSCA DAM SPILLWAY GAP ON RAUL RECE

Radu Lorin JUMANCA¹

Serban-Vlad NICOARA¹

Abstract – The paper presents a structure analysis regarding a concrete passage over a specific hydraulic discharger. The structure approach, following a previous hydrotechnical design, was performed by the help of dedicated software ROBOT v.7. Even if the structure complexity is not very high and the output is in the expected direction, still the approaching method shows all the advantages related to the digital analysis: simple but very coverable modeling, fast run, detailed results of high precision with a representative interface, possibility of design improving. The presented subject is part of a complex project concerning the hydrotechnical development of Rusca Dam on Raul Rece, Caras Severin, part of the “Bistra - Poiana Marului – Ruieni - Poiana Rusca” Hydropower System accomplished by the paper first author.

Key words: spillway bridge, structure, numerical modeling, stress and strain state.

1. GENERAL VIEW

The hydroelectric system “*Bistra - Poiana Mărului - Ruieni - Poiana Ruscă*” provides the development in power for complex purposes of the upper hydrographic basin of Timiș River. From the various developments that form the hydroelectric system “*Bistra - Poiana Mărului - Ruieni - Poiana Ruscă*” the Poiana Rusca Dam is the subject of this article. “*Poiana Rusca*” - a concrete arch dam, was originally designed for a height of 95m, but then re-designed and executed with a total height of 75m. However this article concerns a trial version of the dam in which its height is 85m (established based on a calculation of flood wave attenuation and maximum wave height plus safety height).

The normal retention level required to be at 640.00 m above the sea level, the top arch was fixed at 645.00 m above the sea level. Minimum level of the dam foundation was established at 560.00 m above the sea level, crown arc length is 254.00 m, width at the base 21.50 m and crown width 5.0 m.

The evacuation of high water, ice and floats, is made through a spillway with three gaps of a length of 30.9 m. Considering the flow with probability of exceeding 0.1% valued at $424 \text{ m}^3/\text{s}$, the maximum discharged overflow of $286.55 \text{ m}^3/\text{s}$ was obtained at

a maximum water head of 2.75 m. Front length was fragmented by two abutment piers of 2.0m thickness each in three equal spans of 10.30 m each.

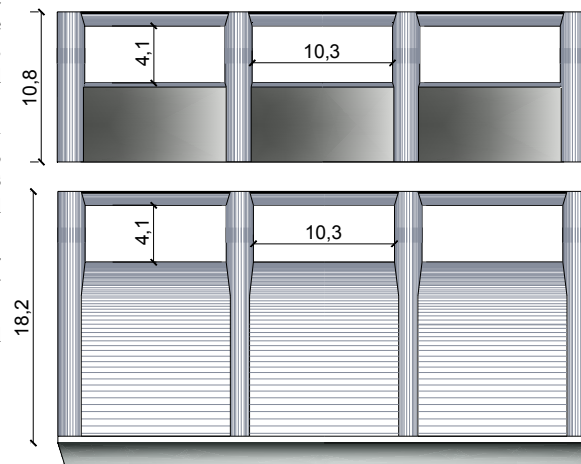

Figure 1.1 Upstream and downstream views of the top discharger

The following work shows the structural calculations of the concrete bridge crossing over of the top discharger (practical shape front spillway) achieved by the help of ROBOT program.

2. STRUCTURE MODELING, STRESS AND DEFORMATION

Concrete structural elements were pre-dimensioned to ensure a proper global ductility for the building. The plate will have a total length $L = 38.9 \text{ m}$, width $b = 5.0 \text{ m}$ and thickness $h = 0.20 \text{ m}$. Two beams were considered for supporting the entire plate length, with their cross section height of $h = 1.10 \text{ m}$ and width of $b = 0.50 \text{ m}$. In the example covered by the paper the beams are consider continued over the intermediate bearings and fixed in the sides abutments.

The modeling was done as bar and plate type elements, followed by loading them (Figure 2.1) with permanent weight (the default set of concrete for

¹ Faculty of Hydrotechnical Engineering from Timisoara, Water Developments & Land Reclamation and Improvement Dep., Str. George Enescu nr. 1/A, 300022 Timisoara, e-mail: jumancaradu@yahoo.com

specific weight $23.56 \text{ kN} / \text{m}^3$, the weight of the covering asphalt layers) and a temporary uniform distributed load (Table 2.1). Regarding the plate, it was automatically divided into triangular finite

elements with relatively uniform size of about 0.5m. The concrete elasticity module was considered with its default value of $2.48 \times 10^7 \text{ kN/m}^2$.

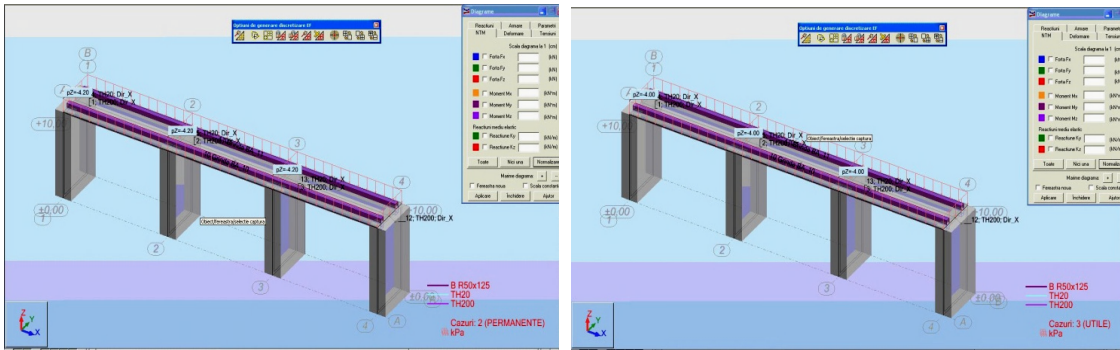

Figure 2.1 Modeling the structure and implementation of permanent and useful tasks

Table-2.1

Caz	Tipul de incarcare	Lista	Valori incarcare (m) (kN) (Deg)
1:GREUTATE	greutate proprie	11a5 10la13	' PZ Negativ Factor=1,00
2:PERMANEN	incarcare uniforma		' PZ=-30,00(kN/m)
3:UTILE	forta pe bara		' FZ=-500,00(kN) X=0,50 relativ
3:UTILE	incarcare uniforma		
3:UTILE	incarcare uniforma		
2:PERMANEN	(EF) uniform pe suprafata 4 5 13		' PZ=-4,20(kN/m2)
3:UTILE	(EF) uniform pe suprafata 4 5 13		' PZ=-4,00(kN/m2)
*			

The linear analysis of the structure was conducted considering the ultimate limit state and was performed for two load combinations, "Fundamental1" and "Fundamental2" (Table 2.2), the loads being adjusted by the proper safety coefficients.

After running the program, the results provided were the bending moment effort and the shearing force diagrams respectively, for both element type, beams and plate. The deformed shape was also given for the

two load combinations.

Bending moment diagrams for continuous beams are presented in Figure 2.2. The maximum values for the bending moment obtained in the gap are 495.45 kN.m (in the center of the left opening) and 428.74 kN.m (in the center of the middle opening), while the maximum moment values above the bearings are -994.73 kN.m and -821.84 kN.m (both in the right end of the second gap

Table 2.2

Combinatii	Nume	Tipul analizei	Natura combi	Natura cazului	Definitie
4 (K)	FUNDAMENTAL	Combinatie liniar	SLU	permanenta	(1+2)*1.35+3*1.50
9 (K)	FUNDAMENTAL	Combinatie liniar	SLU	permanenta	(1+2)*1.35+5*1.50

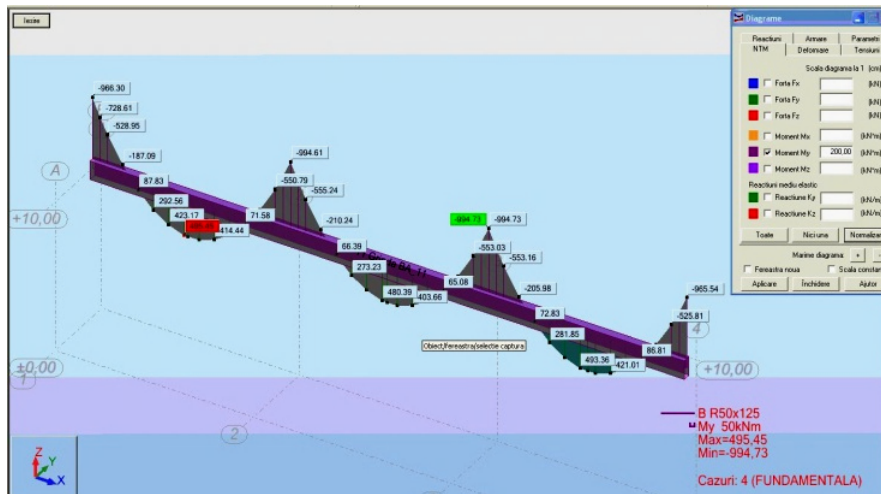

Figure 2.2.a Bending moment on the main supporting beams for load combination "Fundamental1"

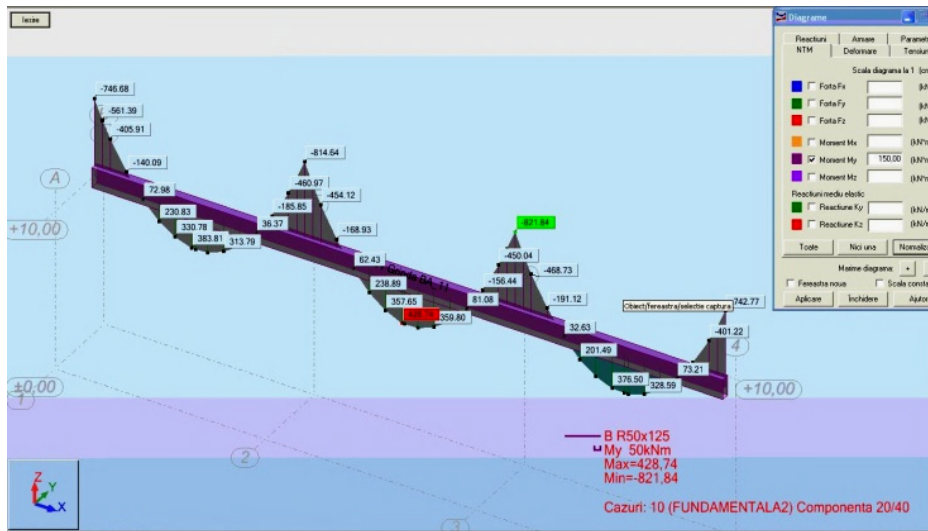

Figure 2.2.b Bending moment on the main supporting beams for load combination “Fundamental2”

Similarly, Figure 2.3 shows as example the diagram for the shearing force corresponding to “Fundamental2” loading case. The maximum values of the shearing force are 480.55 kN - determined for the first load combination at the beam end - and 385.57 (376.14 respectively) kN - determined for the second load combination at the sides of the middle opening.

Regarding to the beams deformation, Figure 2.4 shows that the maximum values for the vertical displacement are 0.5 cm - obtained in the center of the right opening for the first combination - and 0.4 cm - obtained for the second combination in the center of the middle opening.



Figure 2.3 Shearing force on beams for the load combination “Fundamental2”

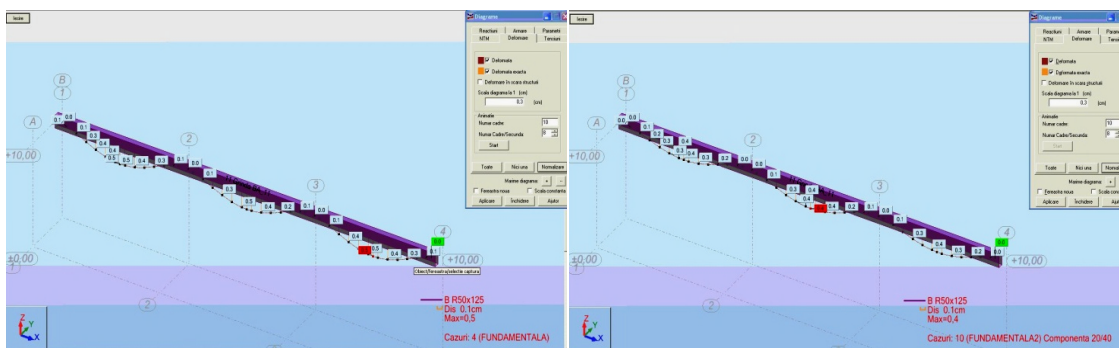

Figure 2.4 Deformed shape of the beams axes for the two load combinations “Fundamental1” and “Fundamental2”

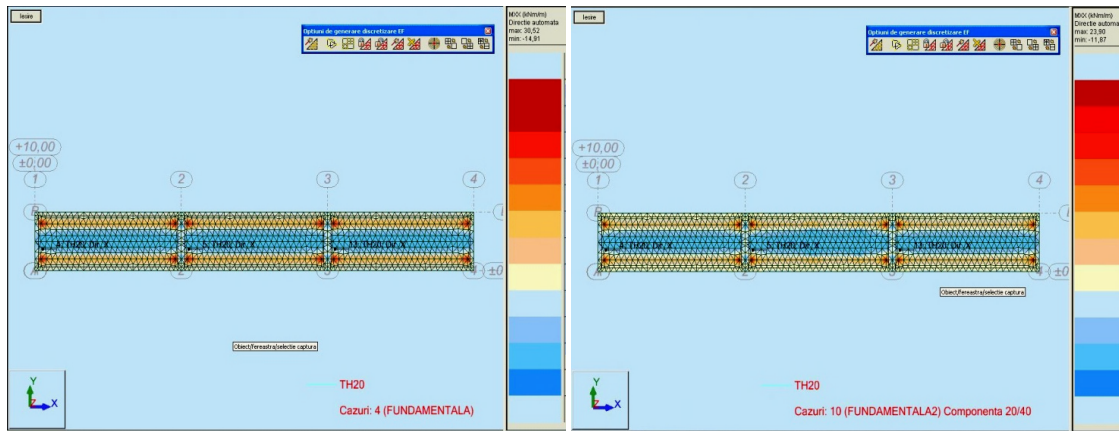

Figure 2.5 Outline variation for plate bending moment efforts M_{xx} , load combinations “Fundamental1” and “Fundamental2”

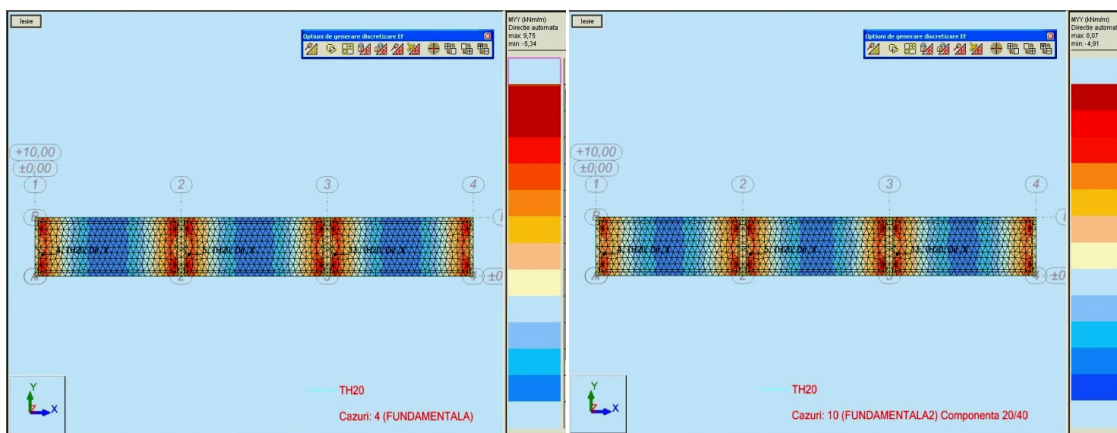

Figure 2.6 Outline variation for plate bending moment efforts M_{yy} , load combinations “Fundamental1” and “Fundamental2”

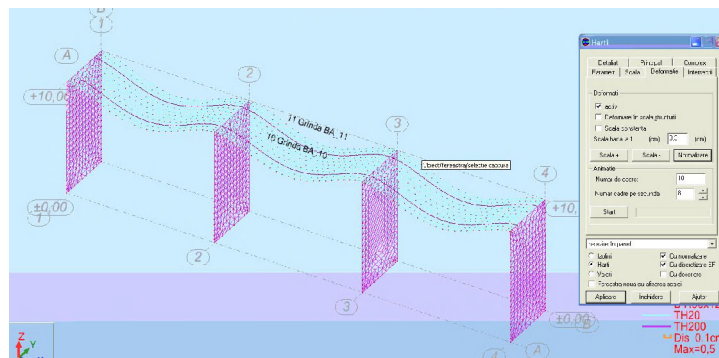

Figure 2.7 The overall bending moment resulted for the overcrossing structure of the front discharger

Regarding the plate element of the structure model, Figures 2.5 and 2.6 present the outlines for the bending moment effort variation obtained in plane (X - Y) for the two load combinations. After running the program the following results were obtained as presented by the pictures: $M_{xx} = 30.52 / 23.90$ kN.m / m and $M_{yy} = 9.75 / 8.07$ kN.m / m - the maximum values in the opening (causing bottom tensions), $M_{xx} = -14.91 / -11.87$ kN.m / m and $M_{yy} = -5.34 / -4.91$ kN.m / m - the maximum values above the bearing elements (causing upper tension). The overall bending resulted for the structure elements is indicated in Figure 2.7

3. CONCLUSIONS

There can be noticed that after running the program the obtained results are detailed, accurate and they are situated in the foreseen limits. The results can also be optimized by simply interfering with the originally develop model. After the results are obtained one can proceed to the reinforcement design by employing the specific module of the same ROBOT software.

4. Bibliography

- [1] Priscu, R., Constructii Hidrotehnice, Vol. I., Ed.Did.Ped., Bucuresti 1974
- [2] Cadar, I., Clipii, T., Tudor, A., Beton Armat, Ed. Orizonturi Universitare, Timisoara 1999
- [3] ****, Robot Millenium – User’s Manual, 2003

