

Tom 51(65), Fascicola 2, 2006

Designing an Audio Application for Bluetooth Enabled Devices

Andrei Maiorescu, Adriana Sîrbu, Ioan Cleju and Ion Bogdan¹

Abstract – Bluetooth wireless technology has opened a new perspective over the services available in personal area networks. Implementation of audio based profiles is a challenge taking in account the diversity of involved devices and circumstances. The paper focuses on the implementation issues concerning the establishment of an audio link between two devices with built in Bluetooth radio chips. The particularities imposed by the protocol specifications are commented. Finally the test application is presented.

Keywords: Bluetooth, audio application

I. INTRODUCTION

Bluetooth technology has become a global wireless specification for a large variety of communications between portable and/or fixed devices. A broad base of vendors representing almost all segments of computer and communications market have chosen to support the development and promotion of this technology in the market place. It is estimated that until 2008, 922 millions of Bluetooth enabled products will be produced [1].

The Bluetooth radio transceivers operate in the globally available unlicensed ISM radio band of 2.4 GHz [2]. The use of a generally available frequency band ensures the fact that this wireless technology can be used virtually anywhere in the world to link up for ad hoc networking within a specified area.

In this context it is expected that Bluetooth technology will be embedded in a whole range of electronic devices in the next few years. This is the reason why it is envisaged that, soon enough, personal area networks will be able to provide surveillance and control of home appliances, materializing the concept of intelligent home.

In [3] the main aspects of the architecture, functions and performances of such a network have been commented. In Fig. 1 we present a possible structure of a home environment personal area network.

This paper focuses on the implementation issues concerning the establishment of an audio link between

two devices with built in Bluetooth radio chips. Section II describes the particularities imposed on the audio links by the protocol specification. In section III we present the design of the audio test application. Finally, conclusions are drawn.

II. VOICE OVER BLUETOOTH

The Bluetooth specifications define two types of links in support of voice and data applications: an asynchronous connectionless (ACL) and synchronous connection-oriented (SCO) link. ACL link support data traffic; the information carried can be user data or control data. SCO links support real-time voice and multimedia traffic using reserved bandwidth. Both data and voice are carried in the form of packets and there can be ACL and SCO links at the same time, [4].

SCO links provide symmetrical, circuit-switched, point-to-point connections, which are typically used for voice. Three synchronous channels of 64 Kbps each are available.

But Bluetooth does not just define a radio system, it also defines a software stack to enable applications to find other Bluetooth devices in the area, discover what services they can offer and use those services. Fig 2 depicts the Bluetooth stack. The specification is broken up into several parts: the Core Specification and the profiles. The Core Specification includes the radio base-band and the software layers which make up the protocol stack. The Bluetooth stack is defined as a series of layers, though there are some features which cross several layers. The profiles give guidelines on how to use the protocol stack to implement different end-user applications.

The first version of the profiles document provides three different profiles covering audio applications: the Headset profile, the Cordless Telephony profile and the Intercom profile. Within the Bluetooth SIG, there are working groups that are producing profiles to support further audio applications[5].

¹ Facultatea de Electronică și Telecomunicații,
Bd. Carol I Nr. 11, 700506, Iași, e-mail mandrei@etc.tuiasi.ro

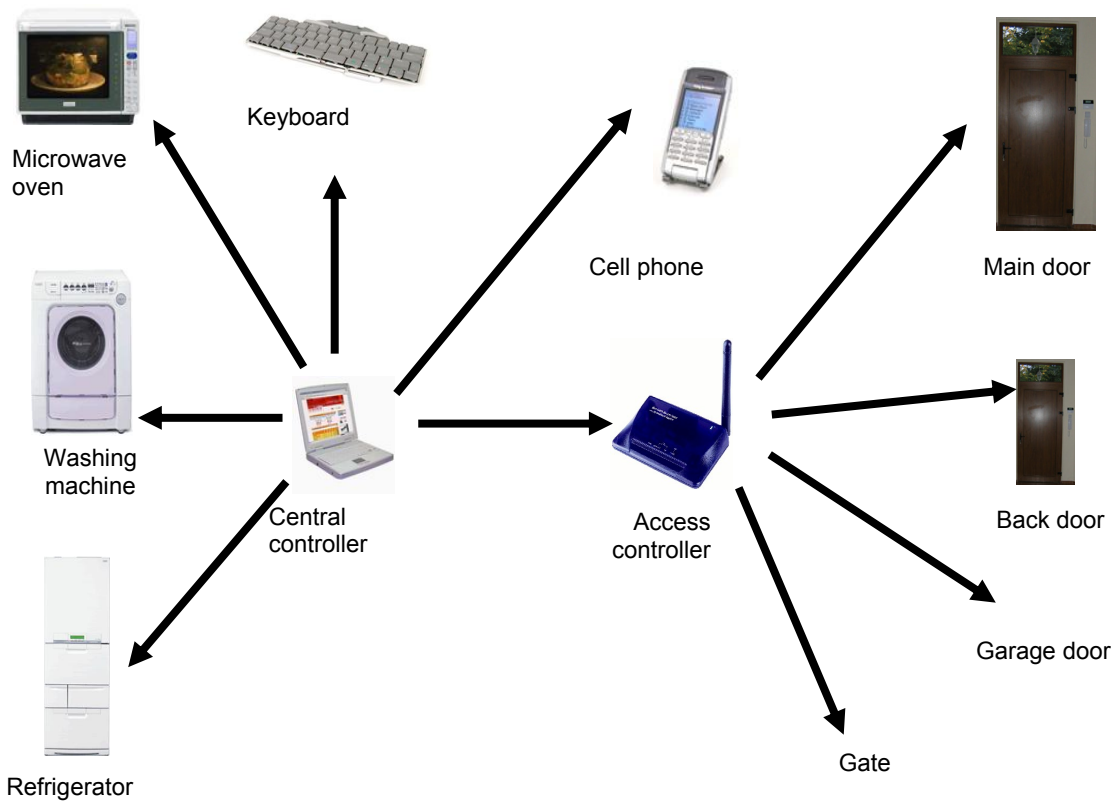

Fig. 1. Architecture of the personal area network for intelligent homes

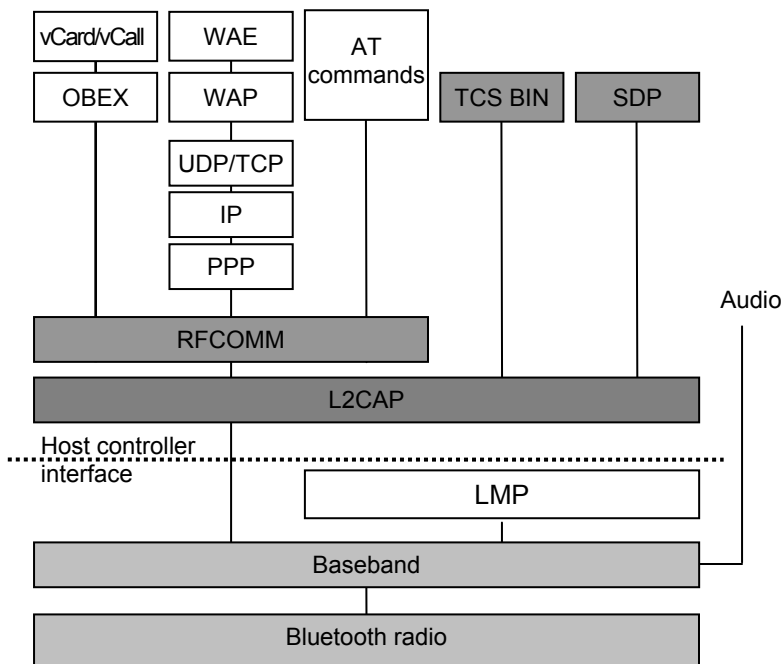

Fig. 2. The Bluetooth stack

LMP - Link Manager Protocol;
HCI - Host Controller Interface;
L2CAP - Logical Link Control and Adaptation Protocol;
SDP - Service Discovery Protocol;
RFCOMM - serial port emulation protocol;
TCS BIN - Telephony Control Protocol (bit-oriented protocol);
AT Commands - Telephony Control Protocol (command-oriented protocol over serial port);

IP, PPP, UDP, TCP - Network Protocols;

WAP, OBEX - interfaces for higher layer Communication Protocols;

The literature mentions that if an application provides a service which is covered by the existing Bluetooth profiles, then one should implement the relevant profile. However, at the moment, there are many possible audio applications which are not covered by

profiles. In this case, one should design a complete proprietary application. As we intend to provide several audio services in a home environment personal area network, our endeavor fits in the second class of applications.

Beyond profiles though, the main core of all envisaged applications is the appropriate design of the audio link. That is why in the next section we present the details of implementation for a possible audio connection between two Bluetooth enabled devices.

III. DESIGN OF THE AUDIO TRANSFER

In order to test the quality of the audio link we have devised a test application called “Talking 2/1”, that is transferring audio links between two audio cards connected on the same computer. Implementing such a test is useful taking into account that both Bluetooth devices and modem are recognized by the system as multimedia devices. This will allow easy integration of the test application in the final product.

The connection diagram for the test application is depicted in the Fig. 3.

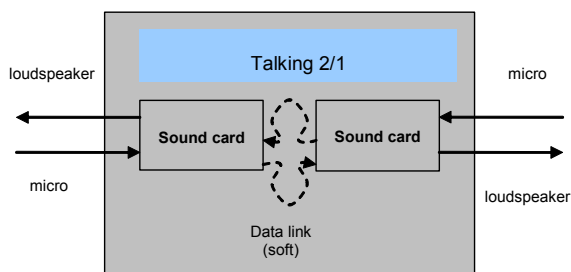

Fig. 3. Connection diagram for the test application “Talking 2/1”

One can see the interconnections between the two audio cards by means of the application. The link is bidirectional. Each card works independently. The record process is performed upon the input channel, data, coming from an A/D converter, are stored in a buffer.

The play process is running on the output channel where data, previously recorded in a buffer, are played using a D/A converter. One can not appropriately synchronize the record and play processes so that the same buffer to be used. This is the reason why, one has to use two buffers: one for recording and one for playing. Considering the same frequency for both processes, one can conclude that the recording and playing of one buffer last for the same time duration. So, one can use two buffers which interchange their roles.

In Fig. 4 we present the status of the buffers at a given moment of time. The input buffer is partially full and is filled, while the playing buffer is partially full and is emptied. Obviously, the two channels work independently and have their own buffers,

Testing this solution on a high-quality acquisition card, it proved to be functional. For the case of sound cards, due to the hardware implementation issues and taking into account the driver operation, the results were unsatisfactory. One supplementary reason of this behavior could be due to the delay introduced by the buffer interchange duration.

One observed that during usual functioning, a small but disturbing delay appears. This delay disappears if data are placed in a waiting queue. We have preferred a four buffer queue structure for each channel, so that at any instance those queues are not empty.

In Fig. 5 one can notice the placement of an empty buffer and a full buffer respectively in the waiting queue. This solution proved to be reliable during the tests we have performed.

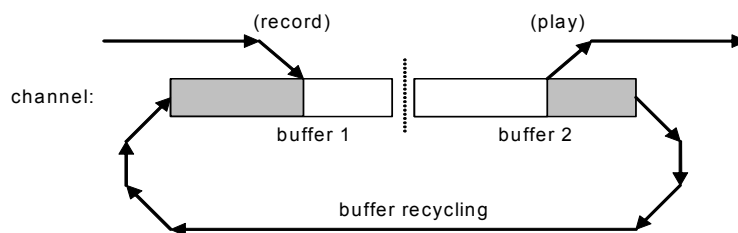

Fig. 4. Double - buffer functioning

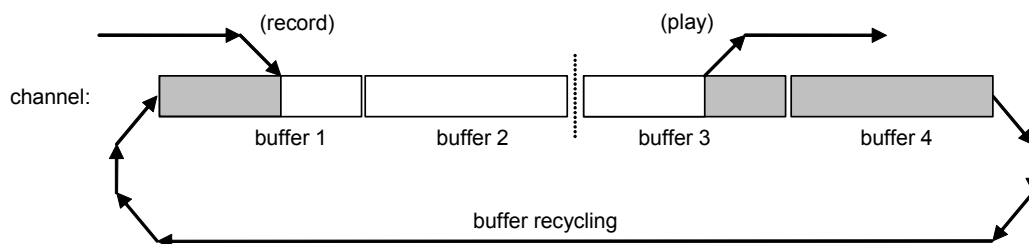

Fig. 5. Four - buffer functioning

Configuring the audio transfer at each location, that is the local sound card “NVIDIA® nForce™ Audio” and the virtual sound card “Bluetooth Audio” is presented in Fig. 6. The transfer is made using 4 data buffers as explained before. The audio channel quality as well as the volume of transferred data are selectable: 22 kHz sampling rate and 16 bits quantization. The buffer length is specified in kbytes and directly influences the total delay.

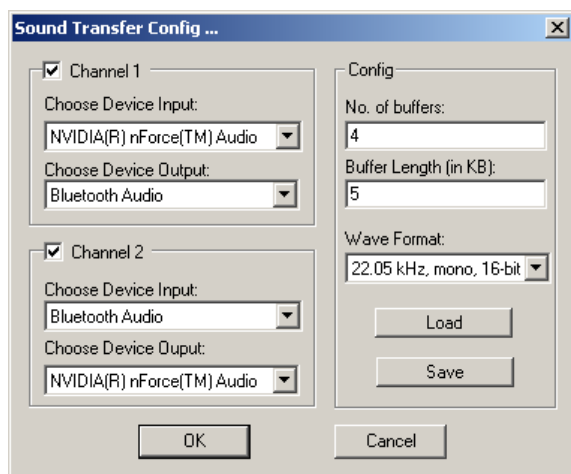

Fig. 6. Sound application interface

The final application, implemented on two separate computers, is called “Talking 2/2” is presented in Fig. 7. It is symmetric implemented and the transfer parameters have to be identical, that is number of buffers, sampling frequency and quantization. The total delay Δt introduced by the application can be calculated using the following relation:

$$\Delta t = 2 \cdot \frac{B}{2} \cdot \frac{DIM}{N} \cdot \frac{1}{f_{es}} + \Delta t_{BT}$$

where:

- B is the total number of buffers;
- DIM is the size, in Kbytes, of each buffer;

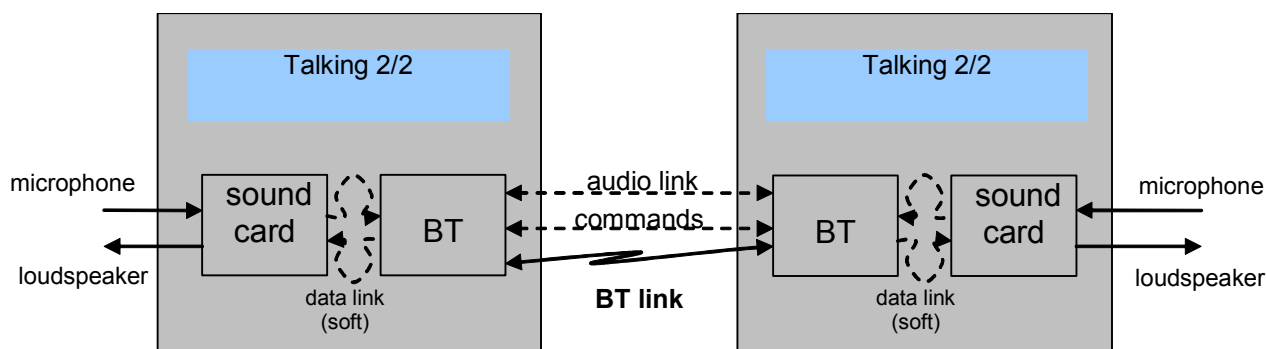

Fig. 7. Connection diagram for the application “Talking 2/2”

- N is the number of bytes per sample (equal to 1 for 8 bits/sample or 2 for 16 bits/sample);
- f_{es} is the sampling rate in kHz;
- Δt_{BT} is the delay on the Bluetooth audio channel.

The sampling frequency f_{es} and the type of quantization decisively influence the quality of the audio signal and the delay Δt_{BT} . A small size of the buffer determines the reduction of the channel delay, but a small size of the buffer is not recommended from the multi buffer functioning.

IV. CONCLUSIONS

In order to design a complete proprietary application to provide several audio services in a home environment personal area network, a test application for an audio link between two Bluetooth enabled devices was designed. The implementation details were commented. Based on this test a new profile for Bluetooth audio application can be developed.

REFERENCES

- [1] <http://www.bluetooth.com/products/>.
- [2] Jeniffer Bray, Charles Sturman – Bluetooth Connect Without Cables, Prentice Hall, 2001.
- [3] A. Sirbu, C. Comsa, I. Bogdan – Retele personale de monitorizare si control la domiciliu in tehnologie Bluetooth: arhitectura, functii, performante – Telecomunicatii, anul XXXII, Nr. 2, 2005 (in Romanian).
- [4] N. Muller – Bluetooth Demistified, Mgraw-Hill TELECOM.
- [5] D. Kammer, G. McNutt, B. Senese, J. Bray (Technical Editor) - Bluetooth Application Developer's Guide: The Short Range Interconnect Solution, Syngress.com.

ACKNOWLEDGEMENTS

This work was partly supported by INFOSOC National Program under Grant INF 134/2004.