

IGBT SPICE MODEL WITH SIMPLE PARAMETER EXTRACTION PROCEDURE

Yassine HADINI

Laboratory of Electrical Engineering and Energy System, Department of physics Faculty of Sciences, Ibn Tofail University, Kenitra, Morocco
Yassine.hadini@uit.ac.ma

Abdelghafour GALADI

Team: Electronic, Electrical engineering, Instrumentation and Imaging, National School of Applied Sciences, Cadi Ayyad University, Safi, Morocco
agaladi@yahoo.fr

Adil ECHCHELH

Laboratory of Electrical Engineering and Energy System, Department of physics, Faculty of Sciences, Ibn Tofail University, Kenitra, Morocco
adilechel@gmail.com

Abstract: *In this paper, an accurate IGBT model is presented. This model is based on the IGBT physic structure. It uses an equivalent circuit which combines an MOSFET, controlled by a voltage controlled voltage source, in series with a diode. All its parameters can be extracted easily from the datasheet information given by the manufacturers. The proposed model presents a good agreement with the measurements. It gives an average error less than 9% for the output characteristics and less than 7% for the transfer characteristic. Moreover, the model is simple and can be implemented in any SPICE-based circuit simulator. A description of the model and the parameter extraction procedure will be provided along.*

Key words: IGBT, SPICE, MODEL, MOSFET, DIODE.

1. Introduction

Since its invention in 1982, the Insulated Gate Bipolar Transistor (IGBT) is device of choice in modern power converter systems targeting medium to high voltage and current applications, synergizing a high-input impedance MOS-gate control with low forward voltage drop bipolar current conduction [1,2]. Unlike the unipolar power Metal Oxide Semiconductor Field Effect Transistor (MOSFET) devices, the on-resistance of the power IGBT devices is very low due to the conductivity modulation of their drift region. As IGBT voltage and current ratings

increase, its application range is extending to high power applications; that is why, in the very near future, the IGBT will be a serious competitor to the GTO [3].

The IGBT structure, as shown in Fig. 1, is analogous to that of the Vertical Double Diffused MOSFET (VDMOSFET), the only difference between them is that the IGBT has a heavily doped p-type substrate in the place of the n-type drain contact of the VDMOSFET. The main role of this extra P type layer is to inject minority carriers (holes) into the main conducting region of the device, modulating its conductivity and decreasing the on-state voltage drop of the device [4]. Consequently, the IGBT has been represented by a couple of a simplified circuit equivalent. The first presents the IGBT as a N-channel MOSFET driving a PNP bipolar transistor in a Darlington configuration, whereas the second consists of an N channel MOSFET in series with a diode [5].

A numerous IGBT models [6–10] have modelled the IGBT using the first equivalent circuit. All of these models cannot describe the IGBT behaviour accurately, without adding the controlled sources, because the wide base in the IGBT differs from the existing discrete power BJT model. Furthermore, these models cannot extract the BJT current gain BF

parameter from the datasheet information like all the other parameters used in the model. While Mihaliç et al [6] chose the maximum possible value for BF parameter as $BF=100$, Kim et al [7] assumed the current gain BF equal to 1. Then, to overcome these objections cited above, an IGBT equivalent circuit, based on the second equivalent circuit, which is composed of an N channel MOSFET in series with a diode, is proposed in this paper.

All needed parameters of the model are extracted easily by using a simple method from the measurements. The MOSFET model parameters are extracted from the transfer characteristic, while the diode parameters are extracted from the output characteristics. Moreover, our model takes into consideration the IGBT transconductance flattening out [11] which occurs in high gate voltage, by adding a voltage controlled voltage source (VCVS) in the MOSFET gate.

The validity of this model has been confirmed by the comparison between simulation and the manufacturer's datasheets. The IGBT chosen to be modelled are the non-punch through HGTP12N60C3 and the non-punch through SGW25N120 [12, 13]. It will be shown that the proposed model gives 9 % as an average error for the output characteristics and 7% for the transfer characteristic, the DC model description will be given in section 2, the parameters extraction procedure will be explained in section 3, the model will be validated by comparing the measurements results given by the manufacturers with the simulation results in section 4 and the conclusion of this paper is given at the end.

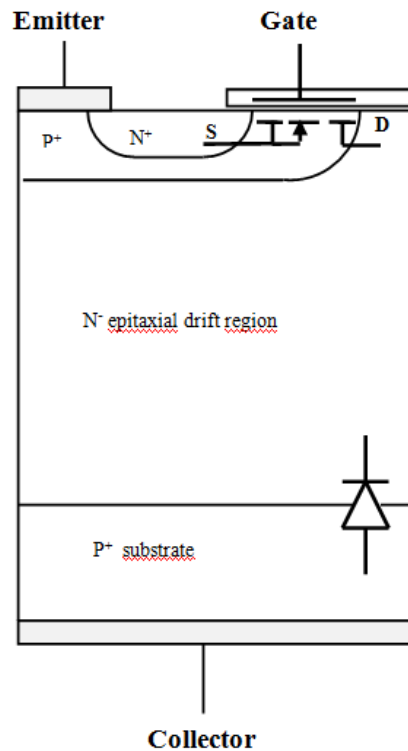

Fig. 1. Cross-sectional view of NPT IGBT structure

2. Model description

The proposed model presents the IGBT as an N channel MOSFET, controlled by an effective source voltage, in series with a diode as shown in Fig. 2. The N channel MOSFET presents the channel region of the IGBT while the diode presents the N- drift/P+ substrate region (Fig.1).

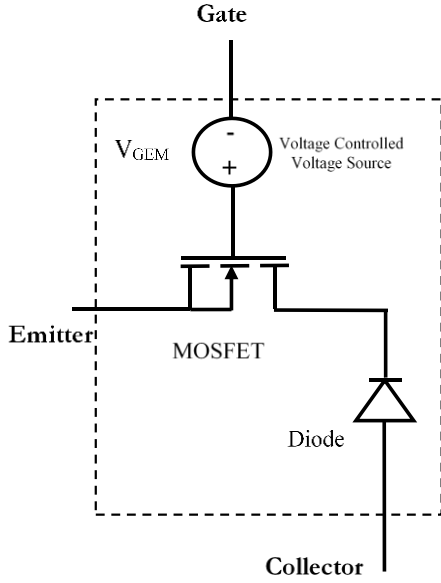

Fig. 2. Schematic of the proposed model for the IGBT

In this modelling, the MOSFET controls IGBT behaviour in the saturation region (Region III in Fig. 3) and also contributes significantly in the linear region (Region II in Fig. 3); therefore, the current in these regions has the following equations:

$$I = \begin{cases} = 0 & \text{if } V_{GE} < V_{th} \quad \text{or} \quad V_{CE} < V_D \\ K_p \left[(V_{GE} - V_{th})(V_{CE} - V_D) - \frac{(V_{CE} - V_D)^2}{2} \right] & \text{if } V_{GE} \geq V_{th} \quad \text{and} \quad V_{CE} < V_{GE} + V_D - V_{th} \\ \frac{K_p}{2} (V_{GE} - V_{th})^2 & \text{if } V_{CE} \geq V_{GE} + V_D - V_{th} \end{cases} \quad (1)$$

V_D is the drop voltage across the diode.

K_p is the channel transconductance parameter (A/V^2) and V_{th} is the threshold voltage.

The diode model intervenes in the cut off region (region I in Fig. 3) (when the collector voltage is under the typical value of the output voltage whose value is between 0.7 and 1) and in the beginning of the linear region. In these regions, the current can be given by the following equation:

$$I = I_s \left[\exp\left(\frac{V_D}{NV_T}\right) - 1 \right] \quad (2)$$

I_s is the saturation current and N is the emission coefficient. They are the two required parameters for the diode model. V_T is the thermal voltage.

In these regions (the cut off and the beginning of the linear region), $V_D = V_{CE}$, because we assume that the

MOSFET has no effect here.

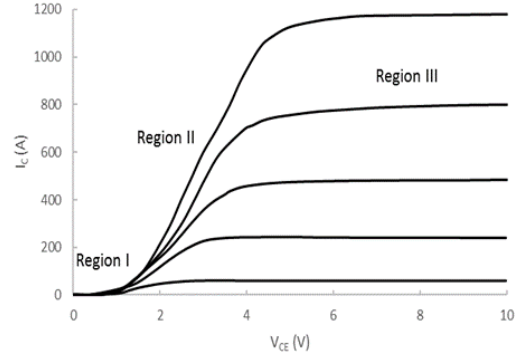

Fig. 3. IGBT output characteristics

As shown in the transfer characteristic (Fig.6 $V_{CE}=5V$), the collector current becomes less sensitive to the increase of the gate-emitter voltage. In this region, the IGBT transconductance becomes quasi constant because of the saturation phenomenon in the MOSFET channel [11]. Thus, to take into consideration this phenomenon in our model, we added a voltage controlled voltage source (VCVS), to the MOSFET gate as shown in Fig. 2. In this modelling, we chose that VCVS depends linearly on the gate voltage. Therefore, the VCVS can be given by:

$$V_{GEM} = \begin{cases} = V_{GE} & \text{if } V_{GE} < V_{GEC} \\ = V_{GEC} + f(V_{GE}) & \text{if } V_{GE} \geq V_{GEC} \end{cases} \quad (3)$$

When

$$f(V_{GE}) = a \times V_{GE} + b \quad (4)$$

V_{GEC} is a critical gate-emitter voltage at the onset of the saturation phenomenon in the collector current. a and b are the VCVS parameters.

3. Parameter extraction

The parameters extraction procedure for a model remains a crucial phase, which affects in a direct way its accuracy to describe the device behaviour. In this model, all the parameters will be extracted from the experimental results.

A. MOSFET parameter

The basic parameters of this model are the transconductance K_p and the threshold voltage V_{th} . The two parameters are extracted from the transfer characteristic in high V_{CE} .

The MOSFET channel controls the IGBT behaviour

in the saturation region [3]. The saturation region of the MOSFET and the IGBT can be assumed to be the same, therefore they have the same transfer characteristic in high V_{CE} . The level 1 MOS Spice model is used to model the MOSFET. In this model, the drain current in the saturation region is given by the following equation:

$$I_C = \frac{K_P}{2} (V_{GE} - V_{th})^2 \quad (5)$$

From the linear portion of the transfer characteristic, we trace a straight line whose equation has the following form:

$$\sqrt{I_C} = \sqrt{\frac{K_P}{2}} V_{GE} - \sqrt{\frac{K_P}{2}} V_{th} \quad (6)$$

K_P can be determined from the slope factor of the $\sqrt{I_C} - V_{GE}$ curve, while V_{th} is the intersection between the extension of the linear portion and the V_{GE} -axis as shown in Fig. 4.

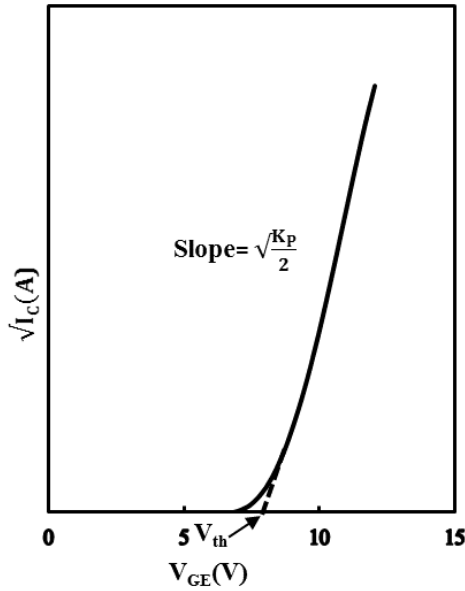

Fig. 4. Square root of collector current vs gate voltage defines V_{th} and K_P .

B. DIODE parameter

The saturation current I_S and the ideality factor N are considered as the essential parameters required to model the diode. They are extracted from the output characteristics in low collector voltage and high gate voltage. The diode controls the IGBT behaviour when V_{CE} is in vicinity of the diode cut-in voltage.

For $V_{CE} \gg V_T$ the equation (2) may be simplified in the following one:

$$\ln(I_C) = \ln(I_S) + \frac{V_{CE}}{NV_T} \quad (7)$$

I_S is obtained from the intersection of the $\ln(I_C) - V_{CE}$ curve and the y-axis while N is related to the slope factor of the curve, as shown in Fig. 5.

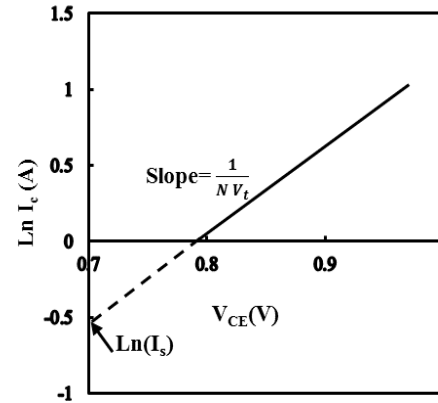

Fig. 5. Natural logarithm of collector current vs collector voltage defines I_S and N .

C. The voltage controlled voltage source parameters

1) Critical voltage V_{GEC}

We traced the curve $I_C(V_{GE})$ for V_{CE} under the saturation voltage, then we determined the critical V_{GE} (V_{GEC}) that corresponds to the voltage from which the transfer curve stops to evolve quadratically with the gate voltage and becomes almost static, as shown in Fig. 6.

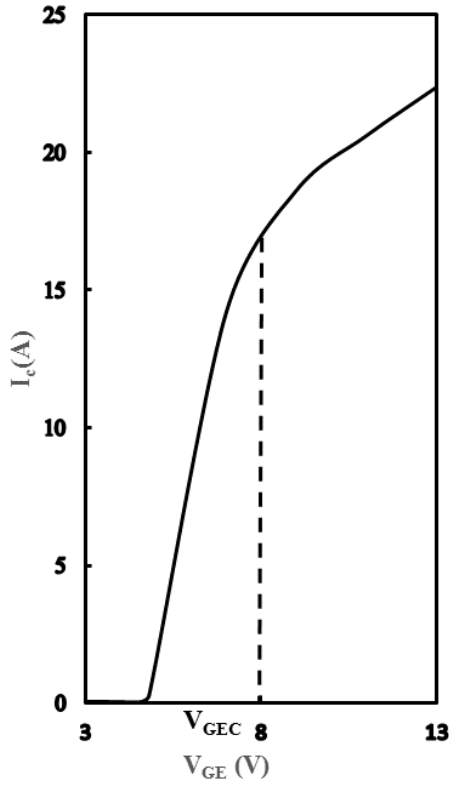

Fig. 6. Collector current vs gate voltage defines V_{GEC} ($V_{CE}=5V$)

2) a and b VCVS parameters

When $V_{GE} > V_{GEC}$, the V_{GEM} can be given by:

$$V_{GEM} = \frac{I_C}{K_P(V_{CE} - V_D)} + \frac{(V_{CE} - V_D)}{2} + V_{th} \quad (8)$$

Where V_D is the voltage drop in the diode calculated by the following equation

$$V_D = NV_T \times \ln\left(\frac{I_C}{I_S}\right) \quad (9)$$

Then from the equations (3), (4) and (8) a and b can be determined.

4. Results and discussion

After having determined the parameters model components by using the methods described above, and in attempt to validate our model, the sub-circuit is simulated using PSPICE. The DC analysis simulation results of the proposed model are compared with the DC characteristics given in the datasheet. The IGBT samples used in this comparison are HGTP12N60C3 (“HGTP12N60C3 PDF Datasheet”, n.d.) and SGW25N120 (AG, n.d.).

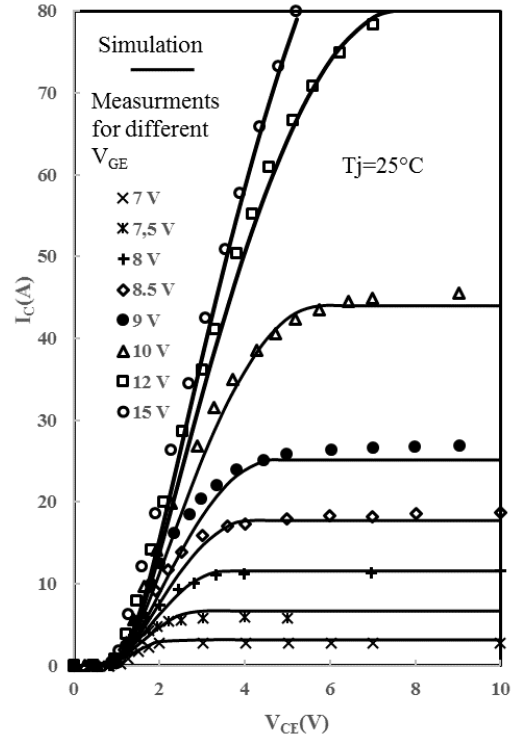

Fig. 7. Measured output characteristics (collector current versus voltage current) in comparison with the simulation results of the proposed model applied to the IGBT HGTP12N60C3 ($T_j=25^\circ C$).

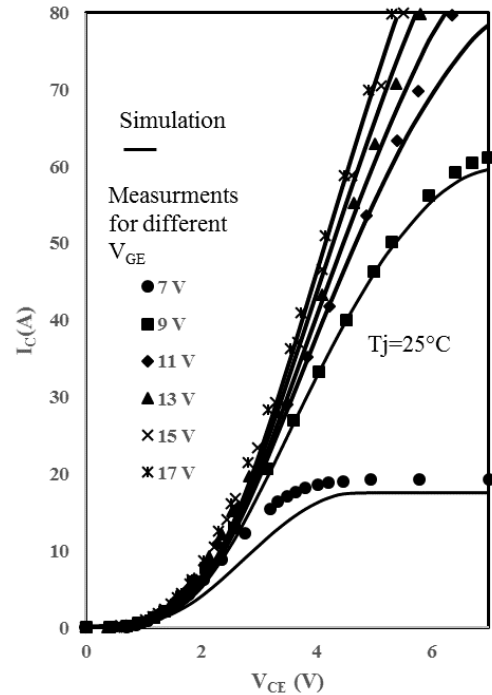

Fig. 8. Measured output characteristics (collector current versus voltage current) in comparison with the simulation results of the proposed model applied to the IGBT SGW25N120. ($T_j=25^\circ C$).

1.

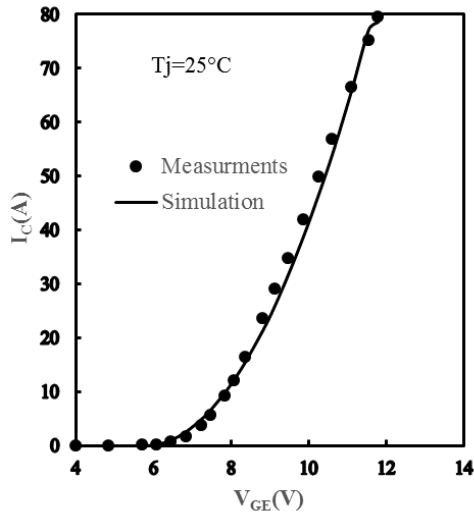

Fig. 9 Measured transfer characteristics (collector current versus gate voltage) in comparison with the simulation results of the proposed model applied to the IGBT HGTP12N60C3 for $V_{CE} = 10$ V ($T_j = 25^\circ\text{C}$).

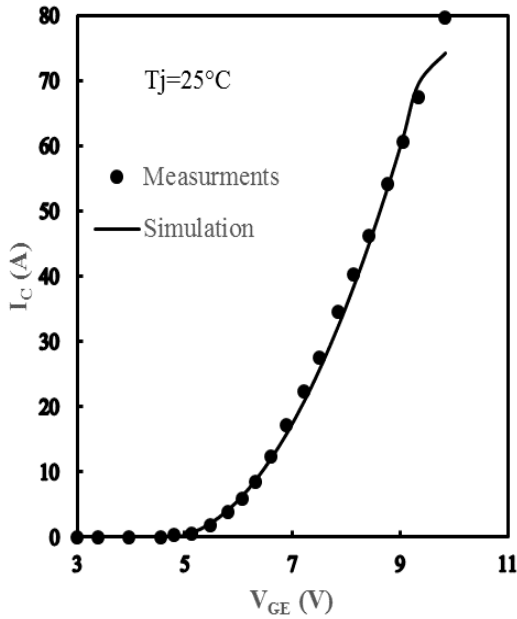

Fig. 10. Measured transfer characteristic (collector current versus gate voltage) in comparison with the simulation results of the proposed model applied to the IGBT SGW25N120. for $V_{CE} = 20$ V ($T_j = 25^\circ\text{C}$).

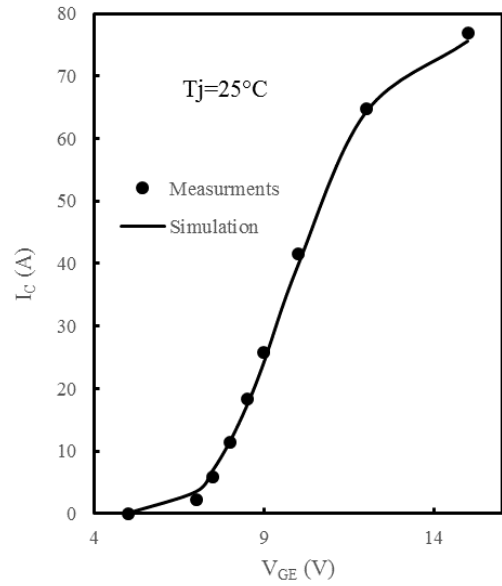

Fig. 11. Measured transfer characteristic (collector current versus gate voltage) in comparison with the simulation results of the proposed model applied to the IGBT HGTP12N60C3 for $V_{CE} = 5$ V ($T_j = 25^\circ\text{C}$).

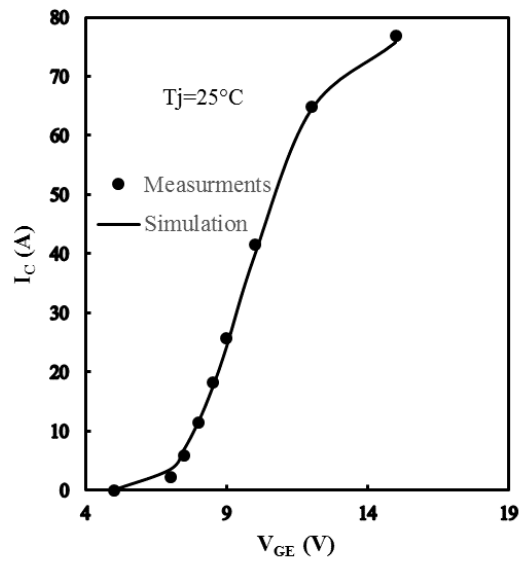

Fig. 12. Measured transfer characteristic (collector current versus gate voltage) in comparison with the simulation results of the proposed model applied to the IGBT SGW25N120 for $V_{CE} = 5$ V ($T_j = 25^\circ\text{C}$)

Fig. 7 and the Fig. 8 show the measured output characteristics versus the simulation results of the proposed IGBT model. Fig. 9 and the Fig. 10 present the measured transfer characteristics compared to the simulation results. As it is obvious from these figures, our model reproduces accurately the DC electrical

behaviour of the power IGBT devices in all regions of operation and for all the V_{GE} values.

The proposed IGBT model presents close results to the measurements given in datasheet. The results of comparison between the measurements results and the simulation results for the output characteristics give less than 9% as an average error, while, for the transfer characteristic, they give an average error less than 7 %.

As for Fig 11 and Fig. 12, they show the comparison results of the simulated and measured transfer characteristics of the IGBT samples used to validate the model for $V_{CE} = 5V$. The added effective VCVS allows describing accurately the reduction in collector current at high gate voltage (the flattening out transconductance phenomenon). The validity of the model allows the validation of the proposed model parameter extraction procedure which is based exclusively on the datasheet's manufactures without need of the process or geometrical parameters.

5. Conclusion

In this paper, an accurate IGBT SPICE model has been proposed and described. The proposed model shows an accurate simulation compared to measurements. The parameters extraction method is presented and all the parameters are obtained from the datasheet characteristics. Our model is simple and can be implemented in any SPICE-based circuit simulator.

REFERENCES

- Baliga, B.J.: *The IGBT device: physics, design and applications of the insulated gate bipolar transistor*, William Andrew/Elsevier, Kidlington Oxford; Waltham MA, p.217-221, 2015.
- Igić, P., Janković, N.: *Review of advanced IGBT compact models dedicated to circuit simulation*. In: Facta Univ.-Ser. Electron. Energ., (2014). Vol. 27 No. 5, p. 13–23.
- Sheng, K., Williams, B.W., Finney, S.J.: *A review of IGBT models*. In: Power Electron. IEEE Trans. On, (2000), Vol.15 No. 6, p.1250–1266.
- Yuan, S., Yuan, S., Hong, Y., Liu, Y.: *SPICE Model for IGBT Temperature Effects Compared with Measurements*. In: 2010 International Conference on Electrical and Control Engineering, (2010), p.3037–3040.
- 'IGBT tutorial: Part 1 - Selection | EE Times', http://www.eetimes.com/document.asp?doc_id=1273173, accessed July 2016
- Mihalič, F., Jezernik, K., Krischan, K., Rentmeister, M.: *IGBT spice model*. In: Ind. Electron. IEEE Trans. On, (1995), Vol. 42, No. 1 p. 98–105.
- Kim, H.S., Cho, Y.H., Kim, S.D., Choi, Y.I.: *Parameter extraction for the static and dynamic model of IGBT*. In: 24th Annual IEEE Power Electronics Specialists Conference, 1993. PESC "93 Record", (1993), p.71–74.
- Asparuhova, K., Grigorova, T.: *IGBT behavioral PSpice model*. In: Microelectronics, 2006 25th International Conference on (IEEE, 2006), (2006) p.203–206.
- Oh, H.-S., El Nokali, M.: *A new IGBT behavioral model*. In: Solid-State Electron., (2001), Vol. 45, No.12, p. 2069–2075.
- Michel, L., Chériti, A., Sicard, P.: *Development of an efficient IGBT simulation model*. In: Electrical and Computer Engineering, 2009. CCECE 09. Canadian Conference on (IEEE, 2009), p.252–256, (2009).
- Khanna, V.K.: *Insulated Gate Bipolar Transistor IGBT Theory and Design*", John Wiley & Sons, United States of America (2004)
- Internet: "HGTP12N60C3 PDF Datasheet", <https://www.fairchildsemi.com/products/legacy/HGTP12N60C3.html>, (2017)
- Internet : "AG, I.T. : Products - Infineon Technologies", <http://www.infineon.com/cms/en/product/power/igbt/igbt-discrete/discrete-igbt-without-anti-parallel-diode/SGW25N120/productType.html?productType=ff80808112ab681d0112ab6d459c0e58>, (2017)