

# RELIABLE POWER ELECTRONICS SYSTEM FOR RENEWABLE ENERGY SOURCES: INVESTIGATION

M.Sujatha<sup>1</sup>, A.K.Parvathy<sup>2</sup>

<sup>1,2</sup>Hindustan Institute of Technology and Science, Padur, Chennai, Tamilnadu

msujatha@hindustanuniv.ac.in, akparvathy@hindustanuniv.ac.in

**Abstract:** Power devices reliability analysis and prediction plays an important role in determining the overall functionality of renewable energy power conversion system. In this paper, the reliability of various DC-DC converters is analysed for variation in frequency, variation in quality of components, variation in temperature etc., Also, reliability block diagram approach is used to determine the reliability of system with and without open circuit faults. Comparative analysis of DC-DC converter is done by using Symbolic Hierarchical Automated Reliability and Performance Evaluator tool. The calculated theoretical values are validated with simulation results.

**Key words:** Failure rate, JANTX, Rds(on), Partial operation, Reliability Block Diagram, SHARPE.

## 1. Introduction

Energy which is naturally replenished and harnessed from natural resources such as wind, solar, biomass, geothermal, tides is renewable energy. It is also termed as alternative source of energy. The state of natural resources in the world is fast declining and there would be scarcity of resources for the future generations. Energy needs of the country will be addressed by renewable energy sources. One of the crucial reasons for the shift to cleaner sources of energy is the reduction of CO<sub>2</sub>. Wind, Solar and Wave energy has been studied extensively for facing energy challenges of future [1].

Power electronic converters are inevitable part of renewable energy conversion systems [2]. They act as an interface between source and load and enable efficient conversion. Control of electrical energy by using different circuit topologies is possible in power electronic converters. As they are used for long working hours under various environmental conditions, their performance and reliability play a major role in determining the overall functionality of the system [3].

The industry has witnessed a revolution in Power electronics in the last few decades. The advanced power electronic components have provided benefits to derive maximum power from solar PV, to connect the system to grid and

to improve the efficiency and performance of renewable systems.

Predicting the reliability of the system is an important valuable tool to improve the design of the circuit and to decide which system is better. The reliability of the converter system can be assessed by decomposing it into its integral components. Estimating the reliability of each of these components and combining them will give the overall reliability of the system. The reliabilities of three different DC-DC converters are compared in this paper. Internal parameter variation due to ageing, effect of frequency variation in reliability and effect of quality of components are discussed. The calculated results are validated using reliability block diagram approach.

## 2. Reliability Comparison of DC-DC Converter

Three converters, Boost converter (basic converter) [4], Luo converter (advanced converter) [5] and three phase Boost converter [6] are considered for reliability analysis. All the converters are designed for the same value of input voltage, output load voltage and frequency. The individual components' failure rates are calculated for finding the overall reliability of the converter. The failure rates include base failure rate and different Pi factors in order to include the real time operating conditions [7].

For power electronic components the failure rate is specified by the equations (1) – (5)

Switch:  $\lambda_p = \lambda_b \pi_T \pi_A \pi_Q \pi_E$  failures/10<sup>6</sup> hours (1)

Diode:  $\lambda_p = \lambda_b \pi_T \pi_C \pi_Q \pi_S \pi_E$  failures/10<sup>6</sup> hours (2)

Capacitor:  $\lambda_c = \lambda_b \pi_{cv} \pi_Q \pi_E$  failures/ 10<sup>6</sup> hours (3)

Inductor:  $\lambda_L = \lambda_b \pi_c \pi_Q \pi_E$  failures/ 10<sup>6</sup> hours (4)

Resistor:  $\lambda_{resistor} = \lambda_b \pi_R \pi_Q \pi_E$  failures/ 10<sup>6</sup> hours (5)

where  $\lambda_b$  = Base failure rate;  $\pi_q$  = Quality Factor;  $\pi_E$  = Environmental Factor;  $\pi_c$ = Construction Factor;  $\pi_s$ = Stress Factor;  $\pi_A$ = Application Factor

### 2.1 Boost Converter

A Boost converter, otherwise called as step up converter, is a DC- DC converter in which the output voltage is greater than the input voltage, without change in power [8]. In Boost converter the sudden variation of input current is resisted by the inductor L. During switch off, inductor stores energy and discharges it during switch on. The time constant of the RC circuit is large and hence the output is almost constant. The circuit diagram of boost converter is shown in the Fig.1

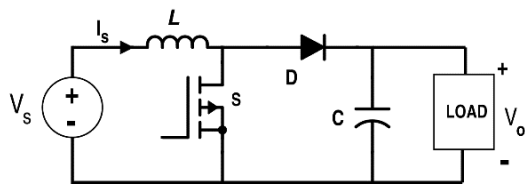

Fig. 1 Circuit Diagram of Boost Converter

#### 2.1.1 Mode 1 operation: Switch On

When the switch is ON, the inductor will store energy and the current through it increases. The diode will be reverse biased and the capacitor will discharge its energy to the load. The circuit diagram for mode 1 operation is shown in Fig.2

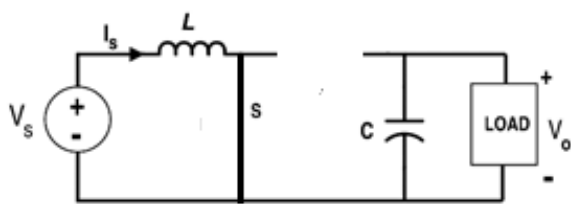

Fig. 2 Switch On operation- Boost converter

#### 2.1.2 Mode 2 Operation: Switch Off

When the switch is OFF, the supply voltage along with inductor voltage will be applied to the capacitor load combination through the diode. Now the inductor will discharge and its current will decrease. The circuit diagram for mode 2 operation is shown in Fig.3

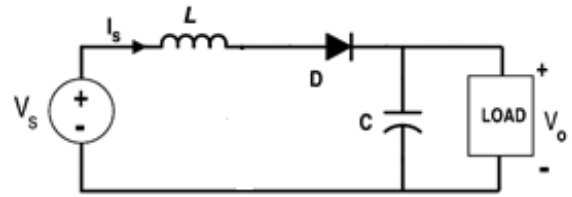

Fig. 3 Switch OFF operation- Boost converter

The Output of Boost converter is given by equation (6)

$$V_o = 1/(1-D) V_{in} \quad (6)$$

where D is the duty cycle  $D = T_{on}/T$ ;  $T_{on}$  = Time for which switch is on;  $T$  = Total Time Period;  $V_o$  = Output Voltage;  $V_{in}$  = Input Voltage

The converter is designed for the following values of components:  $L = 1\text{mH}$ ;  $C = 20\mu\text{F}$ ;  $R = 20\text{ ohms}$ ;  $V_{in} = 12\text{ V}$ ;  $V_o = 15\text{ V}$ ; Frequency = 50 kHz. The output Voltage of the converter is given in Fig. 4

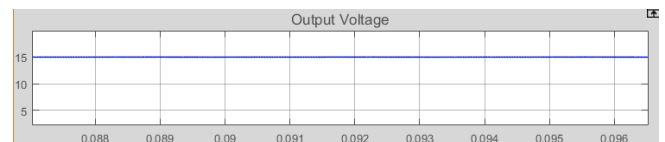

Fig. 4 Output Voltage of the Boost Converter

The waveforms of Current, Voltage, Power across the switch is given by Fig. 5

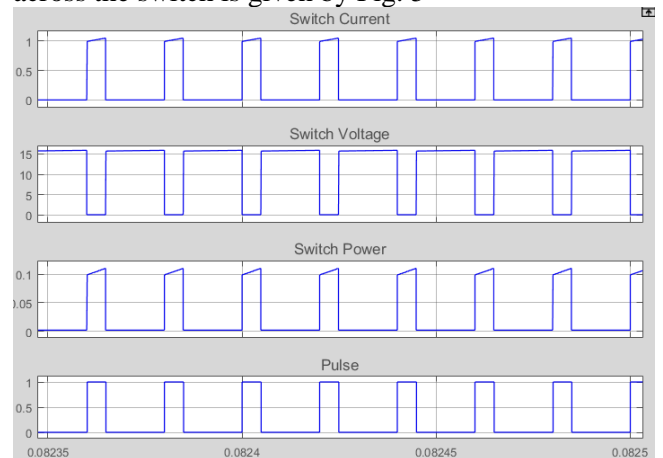

Fig. 5 Switch Current, Voltage, Power waveforms of Boost converter with the given pulse

Table 1 specifies the failure rate of various components of Boost Converter

Table 1. Failure rate of various components of Boost Converter

Component	$\lambda_p$ , Failure Rate Boost (Failures/10 <sup>6</sup> hours)
Switch	0.77040
Diode	0.6909
Capacitor	3.46*10 <sup>-4</sup>
Resistor	0.066
Inductor	2.21*10 <sup>-3</sup>
Failure rate $\lambda_{sys}$	1.5298

The mean time between failures is given by equation (7)

$$MTTF = 1/\lambda_{sys} \text{ hours} \quad (7)$$

$$MTTF \text{ of Boost Converter} = (1/ 1.5298) * 10^6 \text{ hours} = 653656 \text{ hours.}$$

For an estimated time of 10 years the reliability of Boost converter is

$$R = e^{-87600/653656} = 87.4\%$$

## 2.2 Luo Converter

An advanced converter DC-DC Converter which is derived from Buck-Boost converter is Luo converter. It can either step-up or step-down the voltage depending on the duty ratio. Due to its simple structure and high voltage applications, it is widely used. The circuit diagram of LUO converter is as shown in Fig. 6 The energy storage elements are inductors  $L_1$  and  $L_2$ , capacitors  $C_1$  and  $C_2$  and load resistance  $R$ . Diode  $D$  represents the freewheeling diode in the circuit.  $V_{in}$  and  $V_o$  are the input supply voltage and output load voltage. The circuit is operated with a switching frequency of 50 kHz.

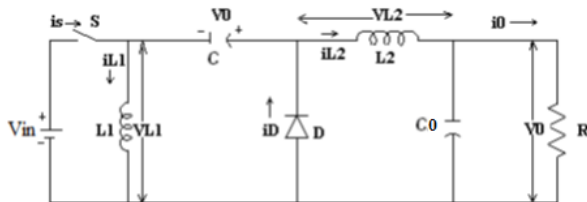

Fig. 6 Circuit Diagram of Luo Converter

### 2.2.1 Mode 1 operation: Switch On

When the switch is ON, the inductor  $L_1$  will receive its energy from source. Inductor  $L_2$  will receive its energy both from source and capacitor  $C$ . Both the inductors store energy and the current through them increases. The diode

will be reverse biased and the capacitor  $C_0$  will discharge its energy to the load. The circuit diagram for mode 1 operation is shown in Fig.7

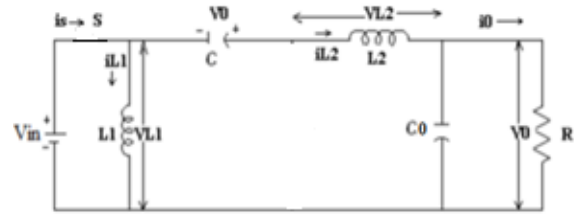

Fig. 7 Luo Converter – Mode 1

### 2.2.2 Mode 2 Operation: Switch Off

When the switch is OFF, the inductor  $L_1$  will discharge its stored energy through the free-wheeling diode. Inductor  $L_2$  will discharge its energy through  $C_0$ - $R$  combination and back through free-wheeling diode. In both the inductors current decreases. The circuit diagram for mode 2 operation is shown in Fig.8

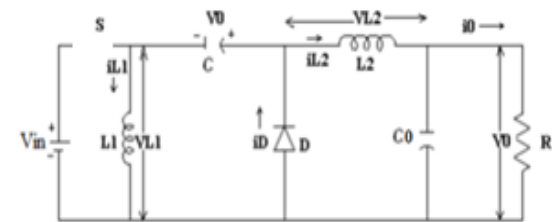

Fig. 8 Luo Converter – Mode 2

The switch is driven by a PWM signal with frequency  $f$  and duty ratio  $D$ . The switch-on period is  $DT$  and switch-off period is  $(1 - D) T$ .

The Output of Luo converter is given by equation (8)

$$V_o = D/(1-D) V_{in} \quad (8)$$

The converter is designed for the following values of components:  $L_1 = L_2 = 1 \text{ mH}$ ;  $C_1 = C_0 = 20 \mu\text{F}$ ;  $R = 20 \text{ ohms}$ ;  $V_{in} = 12 \text{ V}$ ;  $V_o = 15 \text{ V}$ ; Frequency = 50 kHz. The circuit is simulated using MATLAB/Simulink and the results are used for calculating the reliability of converter. The output voltage of the converter is given in Fig. 9

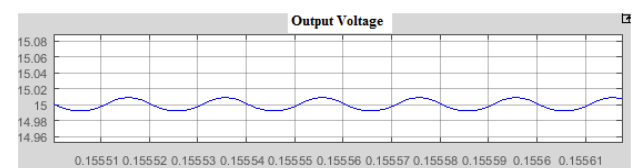

Fig. 9 Output voltage of Luo converter

The waveforms of current, voltage, power across the switch of Luo converter is given by Fig. 10

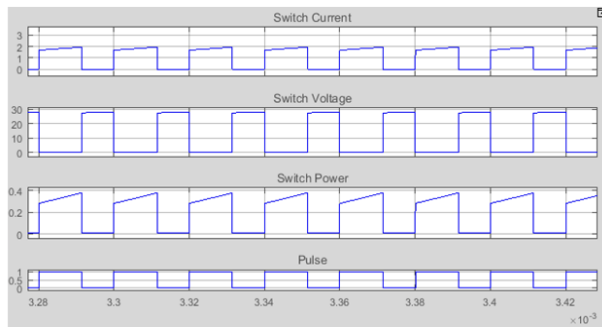

Fig. 10 Switch current, voltage, power waveforms with the given pulse of Luo converter

Similarly, the waveforms of voltage, current and power across all the other components ( $L_1$ ,  $L_2$ ,  $C_1$ ,  $C_2$ ,  $D$  and  $R$ ) are taken from simulation for calculating the failure rate, which is given in Table 2

Table 2. Failure rate of various components of Luo Converter

Component	$\lambda_p$ , Failure Rate Luo (Failures/10 <sup>6</sup> hours)
Switch	0.77448
Diode	1.5696
Capacitor	3.46*10 <sup>-4</sup>
Resistor	0.066
Inductor	2.21*10 <sup>-3</sup>
Failure rate $\lambda_{sys}$	2.4126

The failure rate of the system is 2.4126 failures/10<sup>6</sup> hours.

MTTF = (1/ 2.416) \*10<sup>6</sup> hours= 414070 hours.

The reliability of the Luo converter for an estimated time of is given by equation (9)

$$R = e^{-\lambda t} = e^{-t/MTBF} \quad (9)$$

For an estimated time of 10 years the reliability of Luo converter is

$$R = e^{(-87600/414070)} = 80.9\%$$

The graphical representation of reliability of Luo Vs Boost converter is shown in Fig. 11

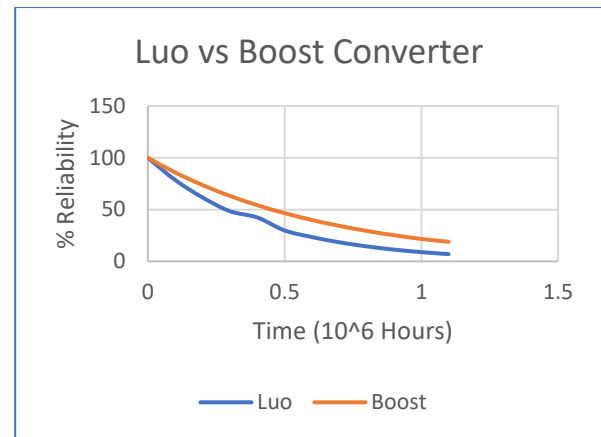

Fig. 11 Reliability of Luo Vs Boost Converter

### 3. Parts selection according to quality

The components of the DC-DC Converter may be procured in a variety of different quality grades in accordance with MIL-HDBK-338 [9] and are designated as JANTX, JANTXV and JANS quality levels. The differentiation depends upon the type and amount of screening performed on the semiconductor device. According to the standard specified by MIL-S-19500, these semiconductors have been tested. The suffix TX to JAN designates “Testing Extra”. Power conditioning tests are done in addition to the JAN sampling tests. This will help to further eliminate faulty parts. For JANTXV an internal visual PRECAP inspection is also done apart from all testing performed on JANTX. For JANS quality level semiconductors, Particle Impact Noise Detection (PIND) Testing is done in addition to all tests conducted on JANTXV. Table 3. gives the reliability of Boost converter with different quality grade components. Table 4. gives the reliability of Luo converter with different quality grade components.

Table 3. Failure Rate of the Boost converter for different grade components

Components of Boost converter	JANS	JANTXV	JANTX	JAN	Commercial
	$\lambda_p$	$\lambda_p$	$\lambda_p$	$\lambda_p$	$\lambda_p$
Switch	4.202*10 <sup>-3</sup>	0.014007	4.202*10 <sup>-2</sup>	0.14007	0.7704
Diode	3.76*10 <sup>-3</sup>	0.012562	3.768*10 <sup>-2</sup>	0.125627	0.6909
Capacitor	1.89*10 <sup>-6</sup>	6.3*10 <sup>-6</sup>	1.89*10 <sup>-5</sup>	1.89*10 <sup>-4</sup>	3.46*10 <sup>-4</sup>
Resistor	3.6*10 <sup>-4</sup>	0.0012	3.6*10 <sup>-3</sup>	0.06	0.066
Inductor	1.2*10 <sup>-5</sup>	4.01*10 <sup>-5</sup>	1.20*10 <sup>-4</sup>	1.6*10 <sup>-3</sup>	2.21*10 <sup>-3</sup>
Failure rate $\lambda_{sys}$	7.975*10 <sup>-3</sup>	0.027815	0.083438	0.214421	1.5298
MTTF (hours)	125377857	35951307	11984817	4663707	653656

Table 4. Failure Rate of the Luo converter for different grade components

Components of Luo converter	JANS	JANTX V	JANT X	JAN	Commercial
	$\lambda_p$	$\lambda_p$	$\lambda_p$	$\lambda_p$	$\lambda_p$
Switch	$4.2 \times 10^{-3}$	0.01408	$4.2 \times 10^{-2}$	0.1408	0.77448
Diode	$8.56 \times 10^{-3}$	0.0285	$8.56 \times 10^{-2}$	0.2854	1.5696
Capacitor	$1.89 \times 10^{-6}$	$6.3 \times 10^{-6}$	$1.89 \times 10^{-5}$	$1.89 \times 10^{-4}$	$3.46 \times 10^{-4}$
Resistor	$3.6 \times 10^{-4}$	0.0012	$3.6 \times 10^{-3}$	0.06	0.066
Inductor	$1.2 \times 10^{-5}$	$4.01 \times 10^{-5}$	$1.2 \times 10^{-4}$	$1.6 \times 10^{-3}$	$2.21 \times 10^{-3}$
Failure rate $\lambda_{sys}$	0.0131	0.0438	0.1313	0.48798	2.4126
MTTF (hours)	76160000	22793165	7616000	2279000	414400

Fig. 12 shows the graphical representation of the comparison of Luo and Boost converter with respect to quality of the component and MTTF.

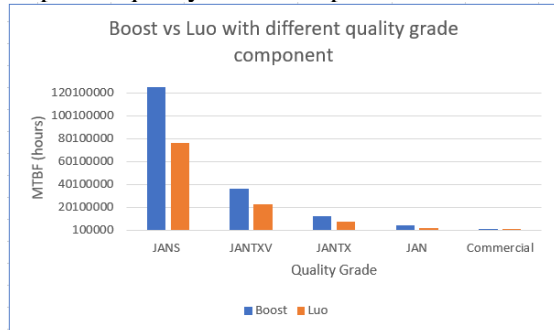

Fig. 12 Luo vs Boost converter with different quality grade components

With JANS quality the reliability of the system is 190 times more than the commercial grade component. Hence depending on where the converter is being used, the quality of the component is selected.

#### 4. Switching frequencies contribution towards Reliability

Switching frequency plays an important role in determining the reliability of the converter [10]. The switching frequency of both Luo and Boost converter is varied from 5 kHz to 150 kHz and the losses in the switches and diodes of both the converters are calculated. Table 5. Shows the result of MTTF variation with switching frequency. Also, the graphical representation of the same is represented by Fig. 13

Table. 5 Frequency vs MTTF

Sl. No	Frequency (kHz)	Luo Converter		Boost converter	
		$\lambda_{sys}$ (failures per million hours)	MTTF (hours)	$\lambda_{sys}$ (failures per million hours)	MTTF (hours)
1	5	2.3569	424278	1.5304	653423

2	25	2.3367	427953	1.5298	653656
3	50	2.3289	429384	1.5298	653656
4	75	2.3283	429489	1.5297	653694
5	100	2.3283	429489	1.5296	653765
6	150	2.3281	429491	1.5296	653765

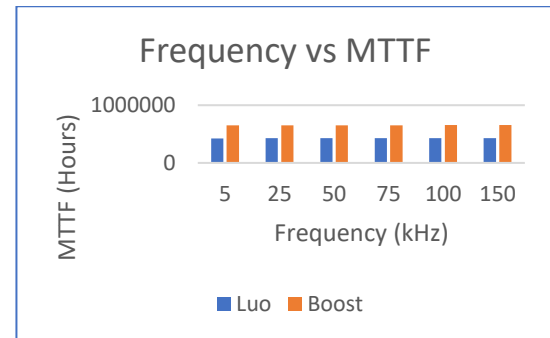

Fig. 13 Luo vs Boost converter with various switching frequency

#### 5. Comparison of reliability indices for variation in system internal parameter

Switches are the most failure prone component in converters. In MOSFET switch, the on-state resistance has been described as the most significant ageing factor. With increase in age, on-state resistance increases. It will also increase because of the stress created in the device, to maintain required voltages and currents when operated in closed loop. As the value of  $R_{DS(on)}$  increases, the thermal stress on the switch increases, which increases the junction temperature and changes the operating point of the converter [11]. This will eventually reduce the reliability of the converter.  $R_{DS(on)}$  increases with the temperature because the mobility of the hole and electron decreases as the temperature rises. For the MOSFET IRF530n, the  $R_{DS(on)}$  at a given temperature can be obtained from the data sheet as shown in Fig. 14

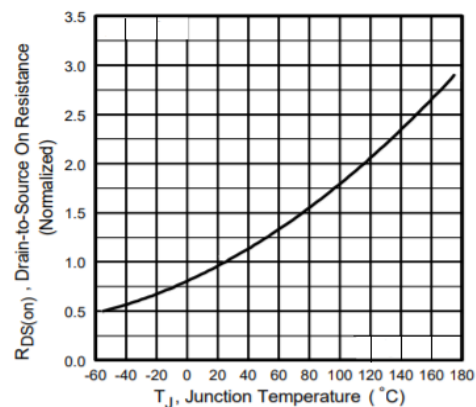

Fig. 14 On state resistance vs Junction temperature of IRF530n MOSFET

For different  $R_{DS(on)}$ , by calculating the switch and diode failure rate, the system failure rate is calculated for both Luo and Boost converter. It is represented by the Table 6.

Table 6. Failure rate of system for different  $R_{DS(on)}$  for Luo converter

$R_{DS(on)}$ (Ohms)	$T_j$ °C	Luo Converter			Boost Converter		
		Switch $P_{loss}$ (watts)	$\lambda_{system}$ (failures per million hours)	MTTF (Hours)	Switch $P_{loss}$ (watts)	$\lambda_{system}$ (failures per million hours)	MTTF (Hours)
0.108	40°	0.2694	2.5582	390899	0.05565	1.7633	567118
0.112	50°	0.2796	2.7682	361245	0.05775	1.97336	506749
0.121	60°	0.3026	3.0072	332535	0.06236	2.2123	452018
0.130	70°	0.3257	3.2739	305446	0.06708	2.47836	403492
0.144	80°	0.3618	3.5702	280096	0.07436	2.7753	360321
0.150	90°	0.3773	3.8951	256601	0.07752	3.10226	322345
0.162	100°	0.4085	4.2551	235012	0.0837	3.46026	288995

From the table it is evident that as  $R_{DS(on)}$  increases, the failure rate of the system increases and the time between failure decreases. The graphical representation of the same is given in Fig. 15

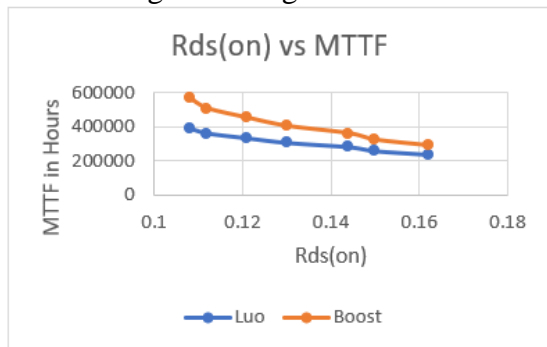

Fig.15 RDS(on) Vs MTBF of Luo and Boost converter

## 6. Three Phase Boost Converter

In three phase Boost converter, phase shift between phases will be  $120^\circ$ . This is similar to single phase or normal boost converter in operation, but the redundancy in leg-level makes it a three-phase converter system. Under normal operating condition all three legs will be operational and the converter will give full output. Under open circuit fault condition of one or two switches, the circuit will give partial output. The main advantage of this circuit is that the system will work even during partial faults. The circuit diagram for the 3-phase converter is shown in Fig. 16. Also, the switch on and switch off condition circuits are shown in Fig.17 and Fig.18

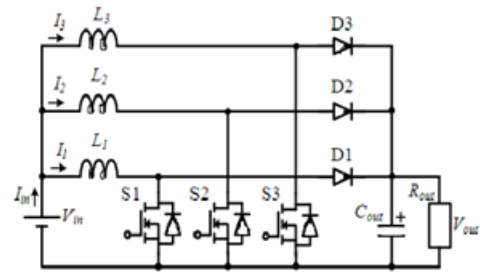

Fig. 16 Circuit Diagram Of 3-phase Boost converter

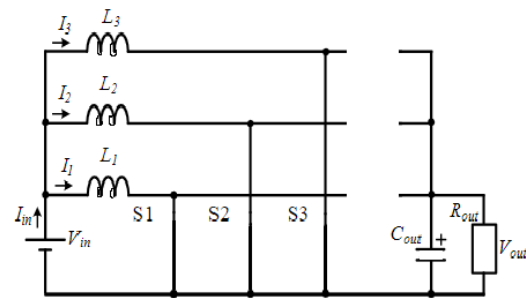

Fig. 17 3-phase Boost converter- Switch ON

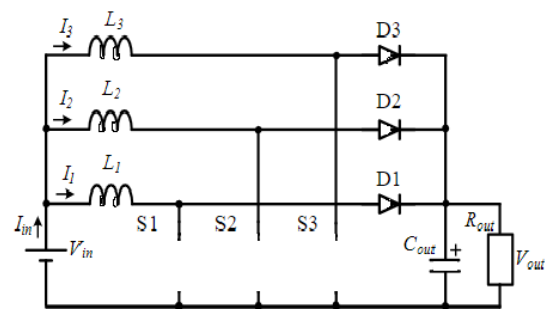

Fig. 18 3-phase Boost converter- Switch OFF

The three phase Boost converter is simulated using MATLAB/Simulink and the current through the inductors is shown in Fig. 19



Fig. 19 Inductor currents of 3-phase Boost converter

The output voltage of the three phase Boost converter is given in Fig. 20

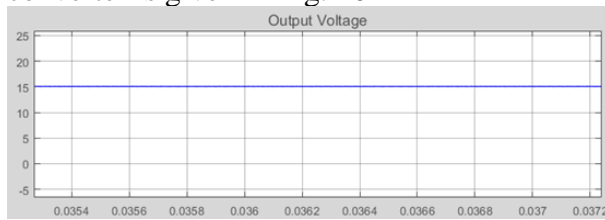

Fig. 20 Output voltage of 3-phase Boost converter

### 7. Reliability Analysis by Reliability Block diagram method using SHARPE tool

SHARPE (Symbolic Hierarchical Automated Reliability and Performance Evaluator) is a modelling tool that analyses stochastic models of reliability, availability, performance, and performability. Using this tool, fault tree analysis, reliability block diagrams analysis, Markov model analysis etc., can be performed. In Reliability Block Diagram (RBD) method of reliability analysis [12], all the components of the system are represented in blocks with their corresponding failure rates. The blocks are connected in series or parallel or a combination of both between the input and output of the system. At least one path should be maintained for the successful operation of the system. The RBD of Boost converter, Luo converter and 3-phase Boost converter are shown in Fig. 21

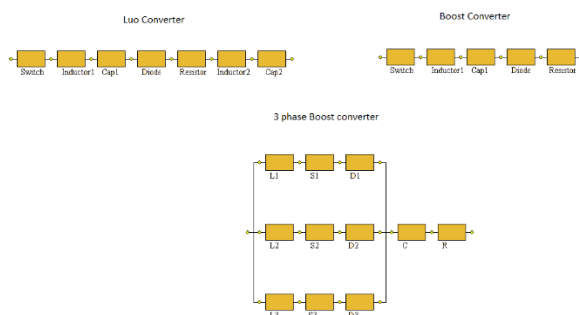

Fig. 21 RBD of Luo, Boost and 3-phase Boost converters

The Boost converter, Luo converter are simulated by using SHARPE tool and their results are validated with the calculated results. The 3-phase boost converter model is simulated for three conditions: i) Three switches functioning ii) Two switches functioning and iii) Single switch functioning. Simulation results are given below.

\*\*\*\*\* Boost \*\*\*\*\*

t=0.00000 Reliability(t): 1.00000000e+000  
t=0.20000 Reliability(t): 7.35820306e-001  
t=0.40000 Reliability(t): 5.41431522e-001  
t=0.60000 Reliability(t): 3.98396308e-001  
t=0.80000 Reliability(t): 2.93148093e-001  
t=1.00000 Reliability(t): 2.15704320e-001  
Mean Time To Failure

MTTFval: 6.556565635e-001

\*\*\*\*\* Luo \*\*\*\*\*

t=0.00000 Reliability(t): 1.00000000e+000  
t=0.20000 Reliability(t): 6.17002206e-001  
t=0.40000 Reliability(t): 3.80691722e-001  
t=0.60000 Reliability(t): 2.34887632e-001  
t=0.80000 Reliability(t): 1.44926187e-001  
t=1.00000 Reliability(t): 8.94197772e-002  
Mean Time To Failure

MTTFval: 4.14070278e-001

\*\*\*\*\* 3phaseboost \*\*\*\*\*

t=0.00000 Reliability(t): 1.00000000e+000  
t=0.20000 Reliability(t): 9.68187507e-001  
t=0.40000 Reliability(t): 8.78001366e-001  
t=0.60000 Reliability(t): 7.48174745e-001  
t=0.80000 Reliability(t): 6.08646840e-001  
t=1.00000 Reliability(t): 4.79051238e-001  
Mean Time To Failure

MTTFval: 1.12192408e+000

\*\*\*\*\* 3phase2switcheboost \*\*\*\*\*

t=0.00000 Reliability(t): 1.00000000e+000  
t=0.20000 Reliability(t): 9.11105105e-001  
t=0.40000 Reliability(t): 7.52023307e-001  
t=0.60000 Reliability(t): 5.89193712e-001  
t=0.80000 Reliability(t): 4.47576283e-001  
t=1.00000 Reliability(t): 3.33408756e-001  
Mean Time To Failure

MTTFval: 8.83164305e-001

\*\*\*\*\* 3phaselswitchboost \*\*\*\*\*

t=0.000000 Reliability(t): 1.00000000e+000  
 t=0.200000 Reliability(t): 6.81709722e-001  
 t=0.400000 Reliability(t): 4.64728144e-001  
 t=0.600000 Reliability(t): 3.16809694e-001  
 t=0.800000 Reliability(t): 2.15972248e-001  
 t=1.000000 Reliability(t): 1.47230381e-001

Mean Time To Failure

MTTFval: 5.21986952e-001

The simulation results show that the MTTF of boost with three switches working is higher than boost with two switches working and boost with single switch working condition. Reliability comparison of Luo converter, Boost converter, three phase boost converter with one, two and all switches working is shown in Fig.22

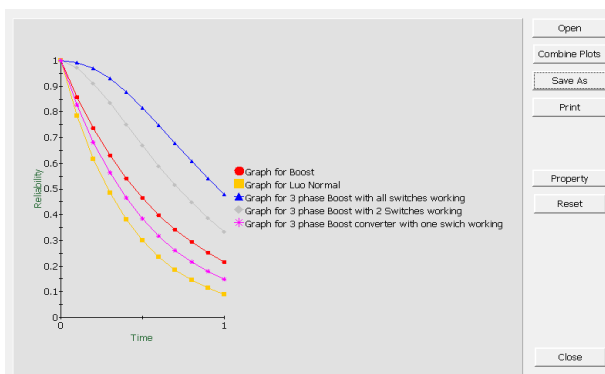

Fig. 22 Reliability comparison of Luo, Boost and 3-phase Boost converter

## 8. Conclusion

In this paper, simulation models of three types of DC-DC converters are constructed using MATLAB/Simulink and their reliability is calculated. The theoretical calculated value is validated using one of the reliability assessment methods; reliability block diagram approach using SHARPE tool. Various factors that affect the reliability of the system such as frequency variation, quality grade of components and ageing related issues such as on-state resistance of MOSFET are considered for analysis purpose. It is found that with increase in switching frequency there is an increase in reliability. Component with JANS grade is 190

times more reliable than commercial grade components. With increase in  $R_{ds(on)}$  of MOSFET, the switch degrades and the reliability of the system decreases. Out of all the converters discussed above, the three phase Boost converter which has redundancy in leg level is the most reliable. This study will help in selecting the converter design specific to needs and applications.

## Acknowledgment:

I would like to thank Dr. Kishor Trivedi, Department of Electrical and Computer Engineering, Duke University for giving me the license to use SHARPE portal

## References

- [1] Talaat, M. & Farahat, M.A. and Elkholy, M.H : *Renewable power integration: Experimental and simulation study to investigate the ability of integrating wave, solar and wind energies*: Energy, Elsevier, vol. 170(C), pages 668-682, 2019
- [2] Frede Blaabjerg, Florin Iov, Remus Teodorescu and Zhe Chen : *Power Electronics in Renewable Energy Systems* : IEEE Proceedings of 12th International Power Electronics and Motion Control Conference, 2006
- [3] F. Blaabjerg, K. Ma and D. Zhou : *Power electronics and reliability in renewable energy systems* : IEEE conference Proceedings of IEEE International Symposium on Industrial Electronics, 2012
- [4] M.Sujatha and A.K.Parvathy : *Reliability Analysis of Boost Converter Used for Solar PV System* : Jour of Adv Research in Dynamical & Control Systems, November 2017
- [5] Anbukumar Kavitha and Govindarajan Uma : *Experimental Verification of Hopf Bifurcation in DC-DC Luo Converter* : IEEE Transactions on Power Electronics, 2008
- [6] M. A. Harimon, A. Ponnira, A. N. Kasiran and H. H. Hamzah : *A Study on 3-phase Interleaved DC-DC Boost Converter Structure and Operation for Input Current Stress Reduction* : International Journal of Power Electronics and Drive System, Vol. 8, No. 4, December 2017
- [7] U.S. Dept. of Defense: *Reliability Prediction of Electronic Equipment, Military Handbook 217F*, Feb. 28, 1995.
- [8] Ned Mohan and M. Undeland : *Power Electronics Converters, Application and Design* : John wiley and sons, 1995
- [9] U.S. Dept. of Defense: *Military Handbook Electronic Reliability Design Handbook, MIL-HDBK-338*, 1998



- [10] Jakob Nömm, Sarah K. Rönnerberg and Math H. J. Bollen : *An Analysis of Frequency Variations and its Implications on Connected Equipment for a Nanogrid during Islanded Operation* : Energies, MDPI, 2018
- [11] D. Umarani and R. Seyezhai : *Reliability assessment of two-phase interleaved boost converter* : Life Cycle Reliability and Safety Engineering, 7(1) (2018) 43-52
- [12] Hoang Pham : *Handbook of Reliability Engineering* : Springer international Edition, 2003