

# Maximum Power Generation in Grid-Connected Photovoltaic System using WOA based Embedded Controller

<sup>1</sup>B.Jegajothi

<sup>2</sup>Dr.c.yaashuwanth

<sup>3</sup>S.Sudhakar

<sup>1</sup>Research Scholar

<sup>2</sup>Associate Professor

<sup>3</sup>Research Scholar

<sup>1,2</sup>Srivenkateswara College of engineering, India

<sup>1</sup>jegajothibalakrish@gmail.com <sup>2</sup>[yaashuwanth@gmail.com](mailto:yaashuwanth@gmail.com) <sup>3</sup>sudhakarganesh7@gmail.com

## Abstract

*A Photovoltaic (PV) cells are generally considered as a significant and striking renewable energy resource. In this document, a Whale Optimization Algorithm (WOA) is designed to congregate the maximum power from PV with the help of embedded regulator. Here, the WOA is a character-stimulated meta-heuristic optimization algorithm, which is stimulated by the bubble-net hunting policy of humpback whales. The uniqueness of designed procedure is to obtain the maximum power from PV array through the alternative solar irradiance and temperature. In this progression, the DC-DC boost converter is employed to develop the presentation of consequences through maintaining the switching pulses. Here, the signals are engendered by means of designed WOA related embedded regulator in this switching control. Thereafter, the voltage source inverter (VSI) is bounded by means of grid associated PV system. The enhancement of designed regulator is taking place by the Xilinx System Generator (XSG) field and legalizes the designed method. Moreover, the switching formats are examined for the PV based DC-DC boost converter. This designed structural design is usually taking place in the MATLAB/Simulink platform which is used to discover the significant features of PV system. At last, the presentation of the designed regulator is estimated and contrasted by the help of base and Jaya algorithm representation*

**Keywords:** PV Array; MPPT Technique; Embedded Controller; WOA; DC/DC Converter; XSG.

## 1. Introduction

In the method of suburban, profitable, and governmental energy outlay, the augmentation of renewable or green energy pressure among government supported financial motivations are creating a model movement [1]. In recent times, the government is employing the difficult economic support method for the dissemination of Distributed Generators (DGs) and PV plants [2]. Here, the significant motivation of extension is considered as the improvement of ultra-low-power electronics, which carry out the minute size of energy through the individual solar, vibration or thermal energy reapers [3, 4]. In the solar energy powered embedded systems, a general preference of tasks are prearranged for the quick development of energy supplying methods. In this method, the electronic systems are used to stimulate a widespread time in the distant ecological location [5]. According to the widespread available energy resources, the conception of “embedded” and “dedicated” device are harmonized as previously [6]. But, the solar energy is recently encompassing numerous concerns for embedded systems [7].

Generally, the embedded controller is encompassing several noteworthy responsibilities to optimize the management and developing reliability. Here, the considered responsibilities are discrepancy identification, auto-modification for sound, obtainable limitations, and temperature boundaries. Here, the identification of distinction among neighboring strings in voltage is known as mismatch [8]. Normally, the responsibilities are carrying out the modern embedded systems feature workload and management distinction [9]. In contrast to other systems, the solar power system is a notable one because they provide an excellent possibility to stimulate electricity and reduce the greenhouse expulsion [10]. Solar energy is generally considered as alternative clean and renewable energy resources through humans. Additionally, the exceptional ecological circumstance is the combination of an effective and appropriate maximum power point tracking (MPPT) algorithm in the PV system [11]. Moreover, PV production systems are encompassing two primary difficulties like the reformation efficiency of electric power invention which is minute in irradiation circumstances and the size of electric power is stimulated through solar arrays. Therefore, the PV production is depending on several extrinsic attributes like segregation (incident solar radiation) phase, temperature, aging and load circumstances [12].

Nowadays, the capabilities of MPPT algorithms are developed by means of numerous investigations. Here, the accessibility of leading circuitry is found out as reasonably. However, the simple hill-climbing or perturb-and-examine algorithms are offering sufficient accuracy and velocity for to estimate the efficiency of PV element in a widespread preference of irradiances [13, 14]. The maximum power tracking is generally exploiting the algorithm of perturbation and inspection progression to modify the operational allocation and observing the substantial modification in power as infrequently. Although it is an excellent algorithm, some uncertainties and instabilities are occurred in the irradiation and load modification as rapidly and unsteadily [15, 16]. Moreover, the incremental conductance (IC) is also considered as an additional progression to distinguish the fraction of conductance with the direct conductance. Here, the IC is offering the tracking method for to capture the identical difficulty as perturb and observe (P&O). The conventional transaction is carrying out among the MPPT speed and oscillation [17, 18]. Afterward, the foremost distribution of MPPT algorithm gives voltage for the logarithmic dependence of PV voltage at irradiation phase. In fact, the linear dependence of PV current at the irradiance phase is helpful for a quick MPPT, but the occurrence of irradiance drop is undeviating to the failure of control algorithm [19]. At last, it is observable that the power of individual DC-DC converter and the

voltage limitation is accomplished in a typical optimization algorithm. It is competent to develop the energy development for the complete converters which are brought about by the operational restriction through the Distributed Maximum Power Point Tracking (DMPPPT) structural design at the indistinguishable time [20].

Therefore, the embedded system based intelligence process is estimated to follow the maximum power from the solar panel. This progression is mainly based on the BFOA and ANN and illustrating the machines or software. The estimated process is employed to follow the maximum power from the solar panel which is founded on the solar irradiance and temperature of the panel. The estimated algorithm is simulated by means of a solitary solar photovoltaic element and a DC-DC converter. The estimated process is predicted and distinguished by a conventional method. The remaining of this document is illustrated as beneath. In section 2 encompasses the related works on tracking maximum power from the solar panel through the embedded system. In section 3, the system clarification and the estimated process is illustrated. In section 4, we depict the investigational consequences. Finally, section 5 concludes the document.

## 2. Recent Research Works: A Brief Review

In literature, a number of research works are available for manipulating and control of tracking maximum power from the solar panel through the embedded system. Some of the works are reexamined here.

A customized P&O algorithm is used to conquer the sturdy-condition oscillation which is the constant perturbation and transaction among step sizes and the convergence time. Generally, it is offered by means of Adel A. Elbaset *et al.* [21]. It employs a regular load procedure for to assist the predictable P&O algorithm which is mainly used to identify the basis of power alteration and facilitate to acquire the accurate conclusion at earliest step alteration in duty sequence for the rapid alteration of weather. The customized P&O algorithm was replicated by means of solitary PV component of 80 W and a DC/DC boost converter.

A field programmable gate array (FPGA) is a multiprocessor system on a chip (MPSoC) which is used to exploit the PV system presentation. It is offered by means of Hesham H. Gad *et al.* [22]. The FPGA related subsystem was employed for maintaining a solitary axis sun tracker and the MPPT by means of three soft-core processors. The sun tracking control format was usually derived from a fuzzy logic control (FLC) algorithm which is directed by a group of time-related solar angle equations. The MPPT was engaged by the variable step-size incremental conductance (INC) process.

Reconfigurable embedded systems are mainly used for the construction of system responsibilities in hard actual-time limitations which is improved by means of Hamza Gharsellaoui *et al.* [23]. Specifically, the method was established from a group of reconfiguration to create a Software Product Line (SPL) which is reprocessed in an analytical and prearranged method to obtain actual-time embedded systems.

A design of large-scale PV array on MPPT difficulty is considered as a large-scale optimization representation which is offered by means of Ruoli Tang *et al.* [24]. Thereafter, a meta-heuristic optimization was engaged to resolve the offline representation. Additionally, the representation analytical control was engaged to accomplish the online MPPT control in actual-time.

Shaowu Li *et al.* [25] has offered MPPT control policy among variable weather parameters (VWP) which is used to accomplish the maximum power point (MPP) of PV system and develop the MPPT flexibility to the changeable weather circumstances. Thereafter, the MPP dissimilarity among PV system with and without DC/DC converter was used to examine the academic origin of MPP control signal. Moreover, the direct association between the control signal and VWP was established by means of the curve-fitting procedure which was considered as the foremost work to execute the policy as temporarily.

In PV systems, a reconfigurable FPGA is executed for the MPPT which is offered by means of Ayman Youssef *et al.* [26]. The MPPT regulator was derived from fuzzy logic and activated at variable irradiance and temperature circumstances. Additionally, it encompasses the PV panel, boost converter, and MPPT regulator. The experienced regulator was executed in VHDL. The VHDL regulator was executed and synthesized on Spartan 6 area programmable gate arrays FPGA.

Ling-Ling Li *et al.* [27] has presented the progression of MPPT among improved gravitational search algorithm (IGSA). Here, the forceful weight was included in the alteration feature of gravity constant. Additionally, the associated features of memory and populace information are included in the modernizing formula of element velocity. The IGSA-MPPT is not only decreasing the tracking time but also enhanced the tracking exactness and diminishes the variation of orientation voltage.

A customized competent variable step P&O (VSPO) algorithm is a challenge to resolve the aforesaid difficulty is presented by means of Ahmed I.M. Ali *et al.* [28]. The VSPO procedure is categorizing the PV-array process area as four working divisions. By these divisions, the step-size was altered as to how the division is remote from the MPP. Three-phase grid-tie inverter (GTI) was employed to attach the system to the conventional grid.

An enhanced bat algorithm is offered by means of Zhongqiang Wu *et al.* [29]. The Chaos search policy was established in the preliminary array to develop the regularity and stochasticity of the populace. The alteration of weight was also established to balance the universal searching capability and the local searching facility. Dynamic reduction recover is diminishing the search series as more efficiently.

From the above research works, we can understand that the ambient energy resources are containing sunlight for to provide abandoned and limitless power supply to embedded systems. Therefore, the supplying power also illustrates the intermittency individuality. Here, the production power of a PV plate is enhanced at noontime than in the morning or evening for design. Generally, a power storage element like a rechargeable battery or super-capacitor is compulsory for sustainable power supply in an embedded system. In an embedded system, varieties of designs are considered with the help of power yielding. Normally, the power yielding systems are exploiting devoid of active control or control elements with stimulating capability. Moreover, the power supplying of logical-power systems are creating additional design difficulty for the communal requirements of prominent efficiency, software-controllability, and stimulate progression as ensure the defense-free independent task. A few

considerable features of the reliable off-the-shelf logical power suppliers are communal with the design obstacle of systems and to originate their utilization difficult for a huge people of researchers. In industrialized and academic circles, numerous MPPT algorithms are available which includes several demanding/general tasks. Each algorithm is derived from its control variables like voltage, current and its dependability progression. The MPPT algorithms are generally based on P&O, incremental conductance, hill climbing, direct control, fuzzy logic control, artificial neural networks, genetic algorithms, particle swarm optimization, short-current pulse, constant voltage, and sliding method control. These algorithms are mostly different from the capacity of sensors, difficulty in algorithm and implementation payments. Here, the significant objective of the designed method is to carry out rapid and accurate tracking management and to reduce oscillations in unsteady weather circumstances. Therefore, we necessitate effective artificial intelligent based method for to follow the maximum power from the solar panel. In this document, some works are obtainable to determine this complexity and the drawback has motivated to execute this study work.

### 3. Proposed Methodology

Here, figure 1 illustrates about the designed method of the grid associated PV array system which encompasses PV array, a DC-DC boost converter, AC grid, and voltage source inverter (VSI) by the help of an embedded MPPT regulator. The presentation of embedded is taken place in the MATLAB/Simulink platform and Xilinx System Generator (XSG) among WOA procedure. Normally, the PV cell is used to generate the electricity from solar energy which includes a nonlinear current-voltage (I-V) features and maximum power point (MPP) on power-voltage (P-V) features. Moreover, the consequence of PV module is relying on solar irradiation and temperature. Generally, it is activated at the MPP for to develop the effectiveness of PV module. So, the numerous peaks on P-V and I-V features of PV array are taken place power failures in the system. Moreover, the PV array is prohibited the DC/DC boost converter for to obtain the maximum power which is congregated by means of WOA regulator.

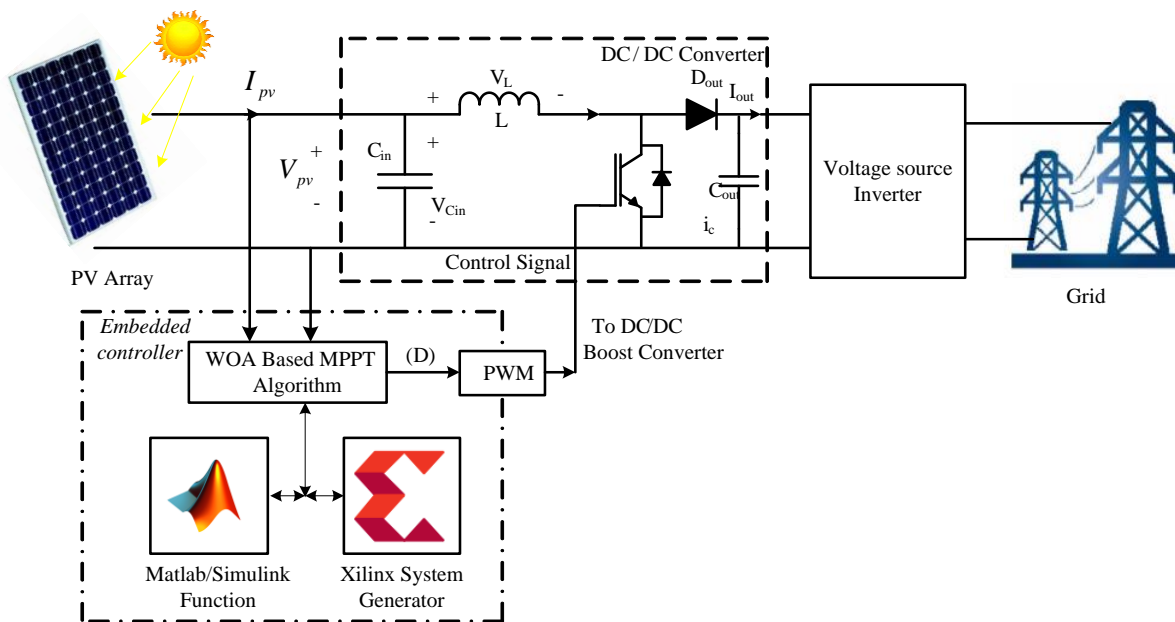

**Figure. 1** The considered proposed PV system with embedded controller

In this document, the WOA procedure is employed to exploit the embedded regulator and maintains the responsibility sequence of the DC-DC boost converter. Additionally, competent structural designs of dissimilar arithmetical representations are utilizing finest design of PV system through MATLAB/Simulink. This structural design is providing a dissimilar system of a graphical user interface which is used to combine the MATLAB/Simulink and XSG [30]. Here, the foremost intention of Xilinx generator is to compute the power output of a PV system for to diminish the complication and structural design which also offers a supplementary characteristic for turn up the system. Subsequently, the reproduction of representation is used to evaluate the power which is offered by means of a PV array on the Simulink with XSG. Finally, the presentation of representation offers a graphical language through a superior level of expansion.

#### 3.1. Problem Statement

The voltage generated by the PV system is low because of its non-linear nature and it is not sufficient for different load application. During irradiance and temperature changing condition the generating power also gets varied. To maintain the maximum power from the PV system the adaptive MPPT algorithm is necessary to track the optimal point. The maximum power point based operating voltage of PV system is very less and not suitable for the high voltage applications. The main applications of PV systems are in either standalone or grid connected configurations. Standalone PV generation systems are attractive as they are indispensable electricity source for remote areas. However, PV generation systems have two major problems such as low

conversion energy in low irradiation conditions and the sum of electric power generated by PV arrays varies continuously with weather conditions. Therefore, how to increase the efficiency of the energy produced from PV arrays are discussed. To overcome the problem, the DC-DC converter topology is used to boost the voltage from low to a high level based on the load condition. Conventional boost converters are commonly used for energy conversion for the PV system. The switching voltage was high for the boost converter during the conversion period. To develop an effective global control algorithm is a fundamental problem to be solved by optimally setting the operating point of the PV module.

### 3.2. An Overview of Proposed System

In this section, a competent procedure of PV system is based on the embedded regulator. It includes the adaptive method for maintaining the optimum control pulse to the DC-DC boost converter. Here, the WOA procedure is exploiting the MPPT regulator for to select the maximum power values from the PV array system. The intention of designed representation and expansion surroundings are carried out by means of MATLAB/Simulink and XSG platforms. The XSG is an Integrated Design Environment (IDE) in the ISE 13.4 expansion group. It encompasses an incorporated design flow which is used to engender the bitstream file from Simulink design surroundings. Moreover, the concept level of XSG is activating predetermined double precision through the quantization and overflow features. Conversely, the Simulink design is activated by quantities of double-precision floating point [31]. The relationship between XSG and Simulink are considered as the gateway blocks. Generally, the XSG is mechanically used to engender the reproduction consequences, RTL synthesis, VHDL/Verilog code and User Constraint File (UCF).

**3.2.1. Modeling of PV array configurations :** Normally, the designed method is enhanced for the computation of finest position in voltage and current at random circumstances which are specified as follows. This representation is used to exploiting the provision of PV components for producer [32]. Therefore, it offers an easy method for to evaluate the power generated by means of PV component which is indicated in equation (1),

$$P^m = V^m \cdot I^m \quad (1)$$

In this equation,  $V^m$  is indicating the maximum voltage position of PV component at random circumstances, which is depicted in equation (2),

$$V^m = V_n^m \left[ 1 + 0.0539 \ln \left( \frac{G}{G^{ref}} \right) \right] + \lambda_0 \Delta T \quad (2)$$

Subsequently,  $V_n^m$  is considered as the maximum voltage of component at standard circumstances (V),  $\lambda_0$  is illustrating the coefficient of voltage at a task of temperature (V/K), T is indicating the temperature, G is indicating the Solar irradiance,  $G^{ref}$  is indicating the orientation Solar irradiance ( $W/m^2$ ) and  $I^m$  is indicating the maximum operating current of PV component at random circumstances [33], which is specified in equation (3),

$$I^m = I_{sc} \left\{ 1 - C_1 \left[ \exp \left( \frac{V^m}{C_2 V_{oc}} \right) - 1 \right] \right\} + \Delta I \quad (3)$$

Here,  $V_{oc}$  is indicating the open circuit voltage of component (V),  $I_{sc}$  is indicating the diminutive circuit current of component (A),  $T = T_C - T_0$  and  $C_1$  and  $C_2$  are indicating the scaling limitation which is computed in equations (4) and (5),

$$C_1 = \left( 1 - \frac{I_{mp}}{I_{sc}} \right) \exp \left( 1 - \frac{V_{mp}}{V_{oc}} \right) \quad (4)$$

$$C_2 = \frac{(V_{mp}/V_{oc} - 1)}{\ln(1 - I_{mp}/I_{sc})} \quad (5)$$

Here,  $I_{mp}$  and  $V_{mp}$  are the maximum current and maximum voltage of PV component. From the features of PV component, the current ( $I_{mod}$ ) is depicted in equation (6),

$$I_{mod} = a_0 \left[ \frac{G}{G^{ref}} \right] \Delta T + \left[ \frac{G}{G^{ref}} - 1 \right] I_{oc} \quad (6)$$

Here,  $a_0$  is the coefficient of current in temperature (A/K). Then the equivalent one diode circuit model of the PV module and its characteristics are illustrated in figure 2.

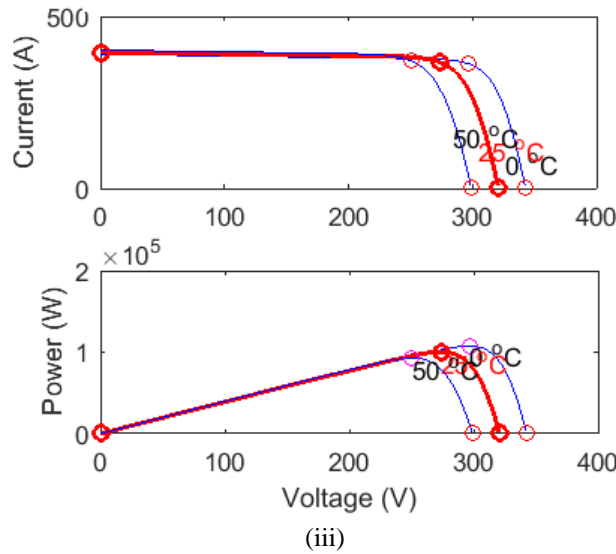
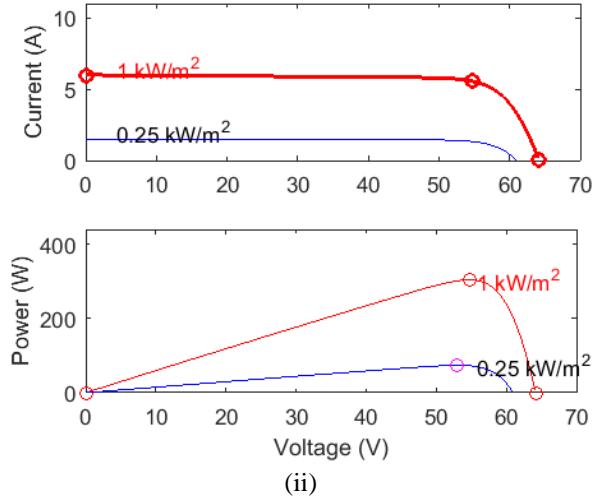
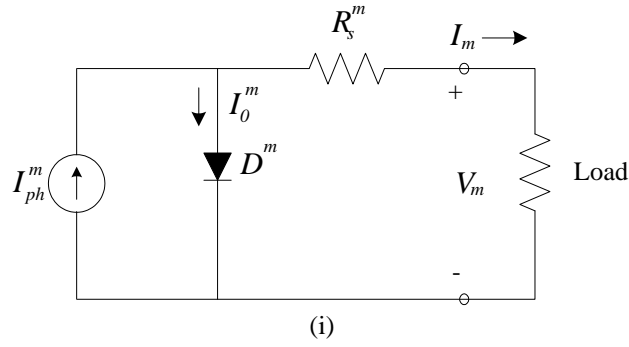

**Figure.2** The equivalent circuit of (i) PV module and the V-I and P-V characteristics in (ii) irradiance (iii) temperature variation conditions

Additionally, the maximum power output is found out for a series and parallel M N component which is depicted in equation (7),

$$P_{mn}^m = FF \left( I_{sc} \frac{G}{G^{ref}} \right) \left( V_{oc} \frac{\ln(k_1 G)}{\ln(k_1 G^{ref})} \frac{T_0}{T} \right) \quad (7)$$

Here  $k_1$  is indicated as constant,  $k_1 = K/I_0$  (around  $10^6 \text{ m}^2/\text{W}$ ) and Form factor ( $FF$ ). The proportion of root mean square value to the standard value of an irregular feature (current or voltage) is known as Form Factor [34]. The standard of entire instant values of current and voltage at one comprehensive sequence is recognized as the standard value of irregular features which is scientifically specified in equation (8),

$$FF = \frac{P^m}{V_{oc} I_{sc}} \quad (8)$$

Additionally, the estimated adaptive method is utilizing a DC-DC converter to distribute the PV panel at maximum power. At this point, the competent method is exploited to determine the difficulty through the deviation of temperature, the segregation and panel load. The several WOA tracking algorithm is mainly exploited to maintain the pulse of DC-DC converters. The progression of designed WOA procedure is depicted in below section.

**3.2.2. Maximum Power Optimization using WOA Technique:** In this section, the WOA procedure is used to congregate the maximum power from the PV array which is also used to enhance the presentation of designed system. Here, the foremost intention of designed WOA procedure is diminishing the form feature, which is scientifically distinct in equation (9),

$$Obj = Min(FF) = Min\left(\frac{P^m}{V_{oc} I_{sc}}\right) \quad (9)$$

Generally, the WOA is replicating the activities of humpback whales [35]. These whales are initially found out the prey's position and assault them by the help of two methods such as encircling them and generate bubble-nets. In the WOA optimization progression, the establishment of prey position is recognized as an investigation of search space. Additionally, the activity of assault is considered as the utilization of area where there are obtained to discover an explanation. In the innovative WOA, the bubble-net is replicating a spiral progression. The humpback whale is normally diving extremely, generate bubbles in a spiral form in the region of prey, and swim to the outside in scheme. They generally assault the miniature fishes which are close to the outside. The arithmetical representation of WOA is mainly illustrating about the movement of encircling the prey, creating spiral bubbles scheme, and hunt for the prey. In an encircling movement, the prey location is indicating by a contender explanation. The encirclement of humpback whales are specified in equation (10) and (11),

$$D = |C.X_p(t) - X(t)| \quad (10)$$

$$X(t+1) = X_p(t) - A.D \quad (11)$$

Here,  $X(t)$  is indicating the whale's location vector,  $t$  is indicating the existing iteration,  $X_p(t)$  is indicating the prey location vector, and  $A$  and  $C$  are indicating coefficient vectors, which are specified in equation (12),

$$\begin{cases} A = 2a.r - a \\ C = 2r \end{cases} \quad (12)$$

Usually, the vector of  $a$  is linearly diminished from 2 to 0 as constantly and  $r$  is indicating an unsystematic vector which is carried out in the array of 0 and 1. The progression of bubble net is indicating the utilization or local search of WOA. In this process, the movement of whale is take place two kinds of method for assaulting the prey. Ere, the initial method is reducing encircle process where the whales swim in the region of prey as reducing circles which is diminishing  $a$  from 2 to 0 through iterations and  $|A| < 1$ . The second one is spiral modernizing location where the humpback whales are swim to the prey in a spiral form scheme [36]. Subsequently the location of whale is modernized in equations (13) and (14),

$$X(t+1) = D^{new} e^{bl} \cos(2\pi l) + X_p(t) \quad (13)$$

$$D^{new} = |X_p(t) - X(t)| \quad (14)$$

At this point,  $b$  is indicating constant which is used to find out the spiral logarithmic form, and  $l$  is an unsystematic quantity which take place in the array of  $-1$  and  $1$ . In the progression of attacking, the whales are revealing two methods as concurrently. So, it is implicit that they carry out reduction encircling method through a possibility of 50% and the spiral representation through the identical possibility to modernize their location, which is specified in equation (15),

$$X(t+1) = \begin{cases} X_p(t) - A.D \\ D^{new} e^{bl} \cos(2\pi l) + X_p(t) \\ \text{if } p < 0.5 \\ \text{if } p \geq 0.5 \end{cases} \quad (15)$$

At this point,  $p$  is indicating the possibility quantity which take place among  $[0, 1]$ . The progression of investigation is mainly used to find out the pray for humpback whales which is considered as the investigation or universal search of WOA. It is establish that  $|A| > 1$  can communicate the search progression. Here, the location of whale is modernized in equations (16) and (17),

$$D = |C.X_r(t) - X(t)| \quad (16)$$

$$X(t+1) = X_r(t) - A.D \quad (17)$$

At this point,  $X_r(t)$  is indicating an unsystematic whale location vector which takes place from the existing populace. It is established by an unsystematic populace of humpback whales in the search space and concludes by means of  $X_p$ . This  $X_p$  is generally modernized by means of choosing the finest explanation from the populace which is derived from the intended task.

**Algorithm 1:**

```

Initialize the whale's populace  $X_i (i = 0, 1, 2, \dots, n)$ ;
Calculate the fitness of each search agent,  $X^*$  is the best search agent;
While ( $t < \text{maximum number of iterations}$ )

    ForEach search agent
        Update  $a, A, C, l$  and  $p$ ;
        If ( $p < 0.5$ )
            If ( $|A| < 1$ )
                Update the position of the current search agent;
            Else If ( $|A| \geq 1$ )
                Select a random search agent ( $X_{rand}$ );
                Update the position of the current search agent;
            End If
        Else If ( $p \geq 0.5$ )
            Update the position of the current search;
        End If
    End For
    Check if any search agent goes beyond the search space and amend it;
    Calculate the fitness of each search agent;
    Update  $X^*$  if there is a better solution;

End While
return  $X^*$ 

```

In this Algorithm 1 describes the WOA procedures, which is evaluated by the measured voltage and current values form a PV array. A flowchart of WOA is generally illustrated in figure 3.

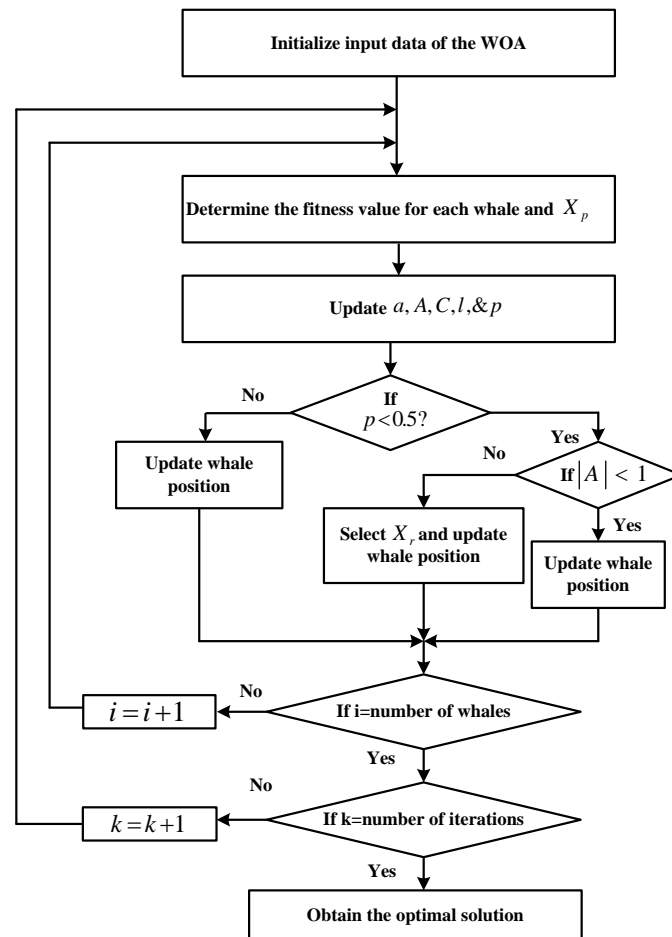

**Figure.3** The flow diagram of introduced WOA technique

According to the designed WOA procedure, the finest control pulses are engendered by the aid of Pulse Width Modulation (PWM) procedure, which is executed by the XSG embedded regulator. The foremost intention of designed WOA embedded regulator is to follow the production of maximum power from the PV array which is derived from the solar irradiance and temperature. Subsequently, the switching control pulses are exploiting the PWM for the DC-DC boost converter. After that, the VSI is bordered by means of a grid. At last, this structural design is taking place on MATLAB/SIMULINK and XSG platform which is exploiting the significant feature of PV system. The grid associated PV system is derived from the replicated consequences to illustrate the efficiency of the designed process, which is illustrated in the subsequent section.

#### 4. Results and Discussions

Here, the replicated consequences and the efficiency of the designed grid associated PV systems are illustrated, which are used to congregate the maximum power from PV array. The introduced PV system contains Intel(R) Core(TM) i5 processor, 4GB RAM and Matlab/Simulink 7.10.0 (R2015a) platform. Additionally, the controlling section takes place on the XSG 14.5 platform. The designed PV system is mainly used to assemble the maximum power from PV array with the help of WOA related XSG embedded regulator. The Simulink and Xilinx representation of introduced grid associated PV system are illustrated in figure 4. Eventually, the designed system is replicated and computed the limitations. Here, the efficiency of the introduced method is verified by the comparison of some conventional procedures like base and Jaya representation.



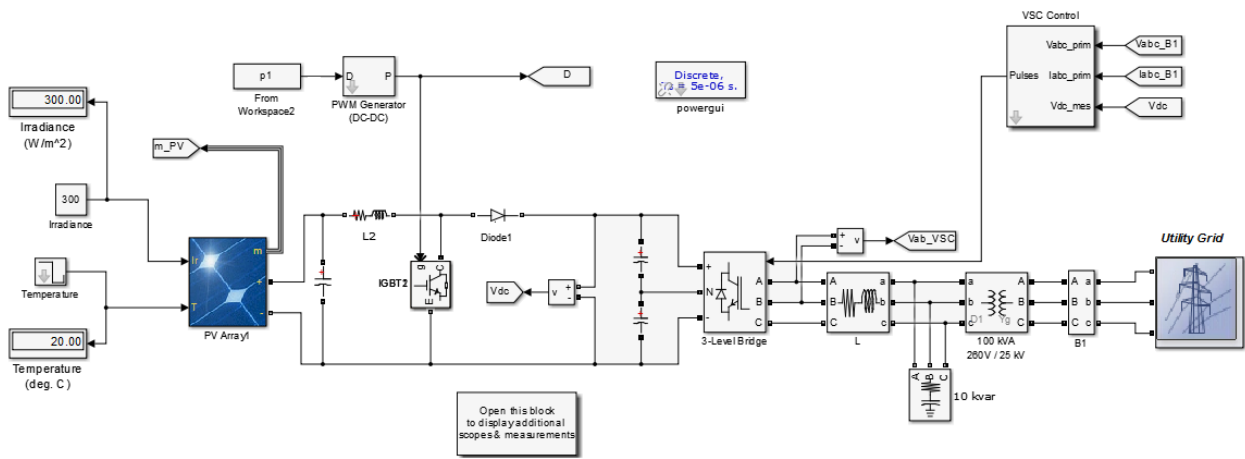

(i)

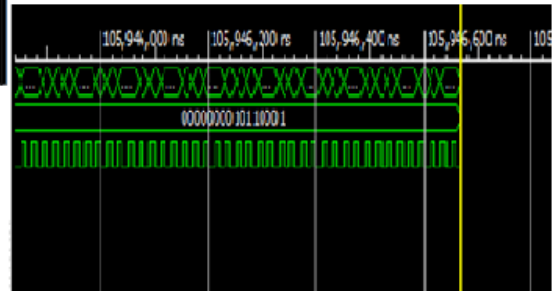
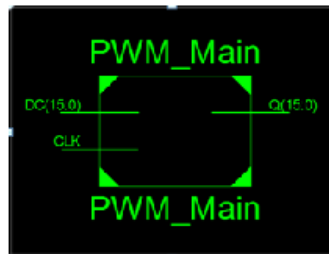
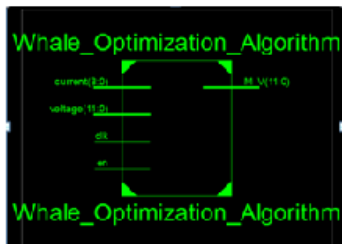

(ii)

**Figure.4** The model of the introduced system using the (i) Matlab/Simulink simulation model and (ii) XSG embedded controller model

From the above figure, the efficiency of the introduced method is examined by the contrast of obtainable representation which is derived from the power limitations. Then the implementation parameters are illustrated in table 1.

**Table 1**The implementation parameters of the proposed system

<i>Parameters</i>	<i>Values</i>
Maximum PV power (W)	213.15W
Open circuit voltage (V)	36.3V
Short circuit current (A)	7.84A
Maximum power point current (A)	7.35A
Maximum power point voltage (V)	29V
Number of cells(Ns)	60
Diode saturation current (A)	$2.825 \times 10^{-8}$ A
Temperature coefficient of Short circuit current	0.102
Shunt resistance (ohms)	313.3991
Series resistance (ohms)	0.39383

In PV array, the introduced grid associated PV system is exploiting the WOA algorithm for MPPT. Here, the embedded regulator is maintaining the control pulse from the DC-DC converter by the XSG. The PV power is diverted by means of the input restriction like irradiance and temperature of PV system. Based on the irradiance, the present analysis is illustrated by means of two conditions such as,

**Case 1:** Performance analysis in constant irradiance

**Case 2:** Performance analysis of Variable irradiance

Here, the output power is altering the current which is used to maintain and congregate the maximum power by the irradiance. By these two conditions, the power limitations are computed and demonstrated as follows.

**Case 1:** Performance analysis in constant irradiance

In this condition, the investigation of regular level irradiance is  $300 \text{ W/m}^2$ , the voltage is 275V, current is 23A, and the power of proposed PV system is 6.325kW. In wished-for PV system, the power limitations are computed by means of proposed WOA related embedded regulator, which is demonstrated in figure 5.

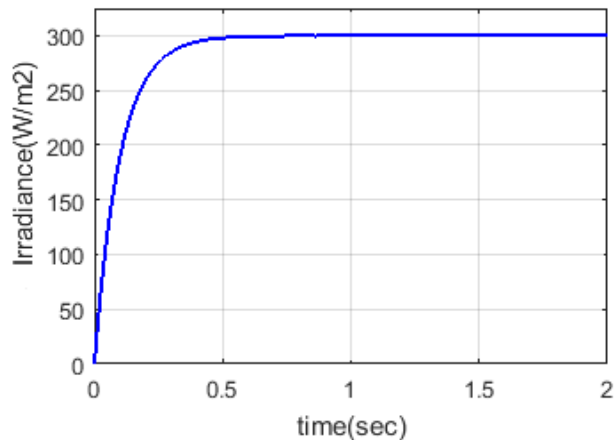

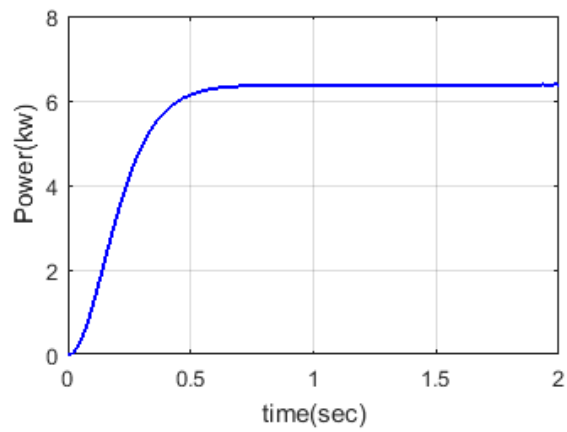
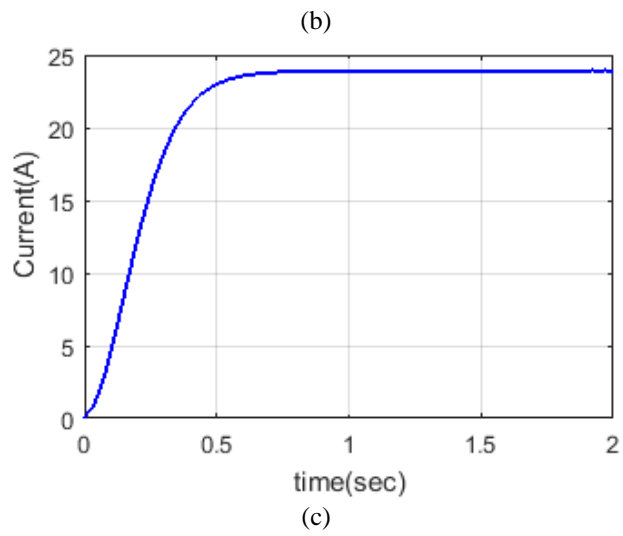
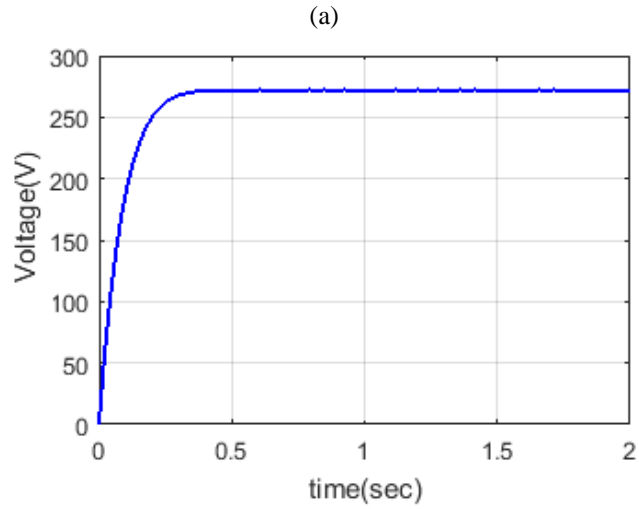

(d)

**Figure.5** Power parameter in PV (a) irradiance (b) voltage (c) current and (d) power in constant irradiance

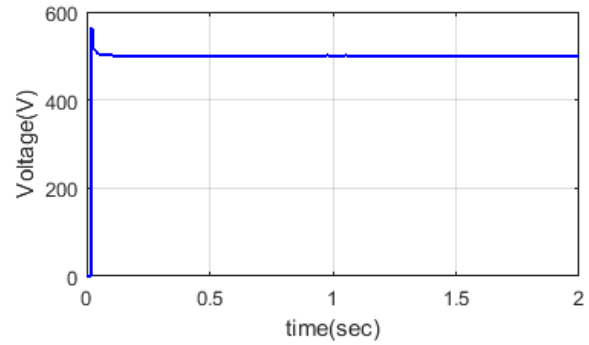

(i)

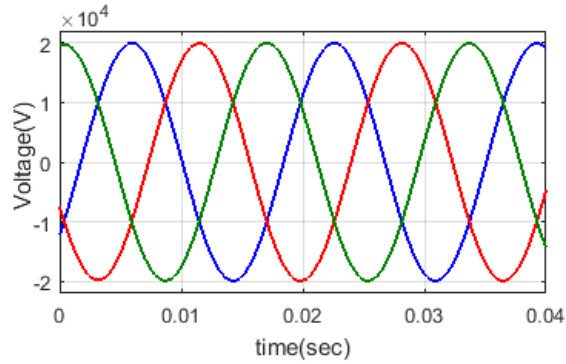

(ii)

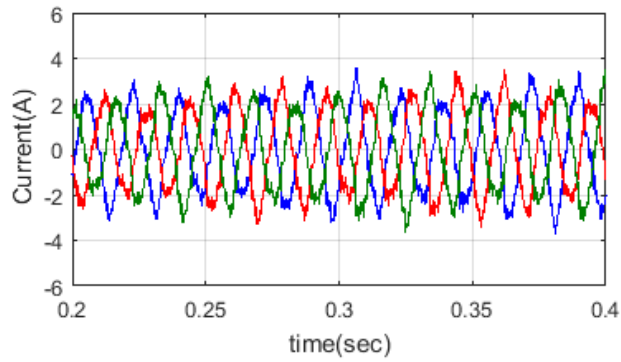

(iii)

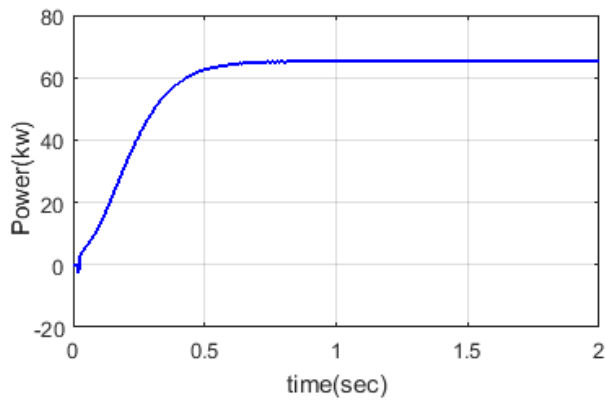

(iv)

**Figure.6** The measured parameters (a) DC link voltage and output (b) voltage (c) current and (d) power grid in constant irradiance

Eventually, the output power limitations are estimated by the replication of proposed regulator. Here, the output is associated with AC grid through the necessities. Therefore, the DC voltage is altered as AC voltage by the aid of VSI. The voltage is developing the presentation of a system for to alleviate the DC-link. According to the alleviated DC-link voltage and equivalent output voltage, the output current is demonstrated in figure 6. Here, the voltage grid is 20kV, the current is 2.95A, and the equivalent power is 59kW. Eventually, the investigation is offered by the non-linear irradiance, which is investigated as below.

**Case 2:** Performance analysis of Variable irradiance

In this condition, the presentation is investigated by the voltage, current, and power from the non-linear irradiance of PV cell. The equivalent power limitations are demonstrated in figure 7, which is also illustrating the variable irradiance and the power limitations. In this non-linear irradiance level, the voltage grid values are 1000W/m<sup>2</sup>, 300W/m<sup>2</sup> and 700W/m<sup>2</sup>. Eventually, the voltage is 250V, the current is 28A, and the power is computed as 7kW. According to the irradiance, the equivalent power will alter consequently.

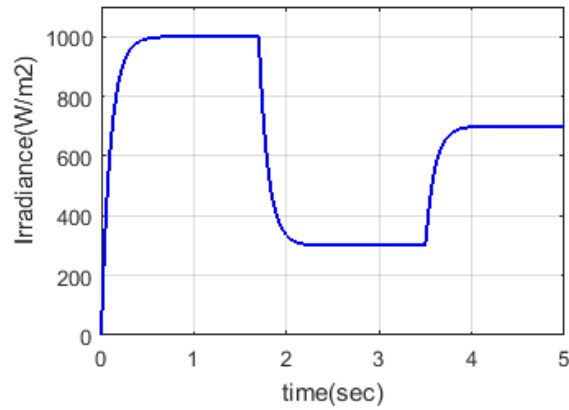

(a)

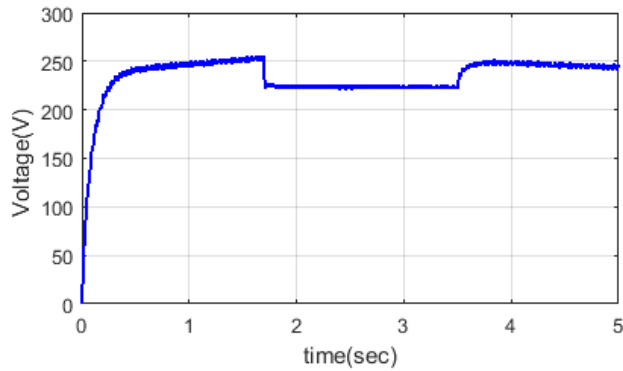

(b)

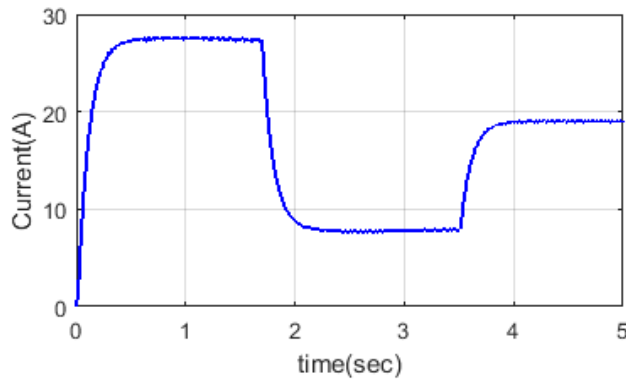

(c)

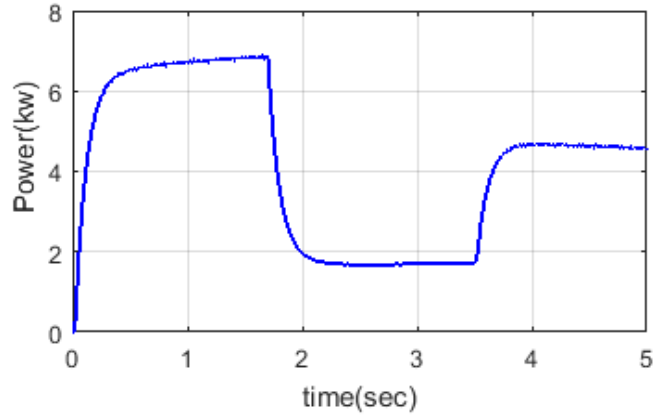

(d)

**Figure.7** The measured PV input (a) irradiance and the output (b) voltage (c) current and (d) power from non-linear irradiance

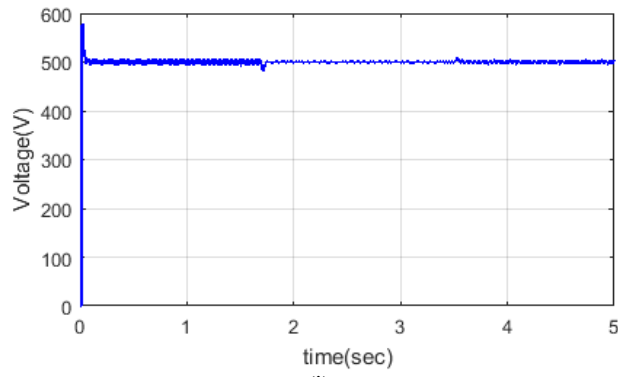

(i)

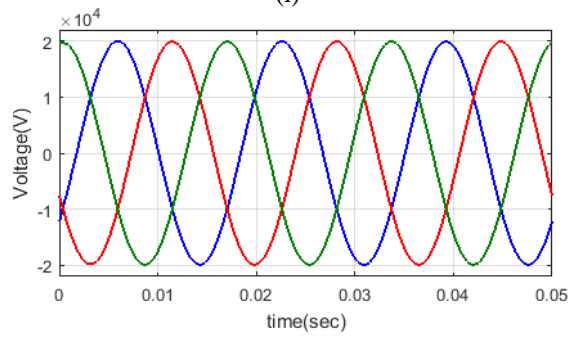

(ii)

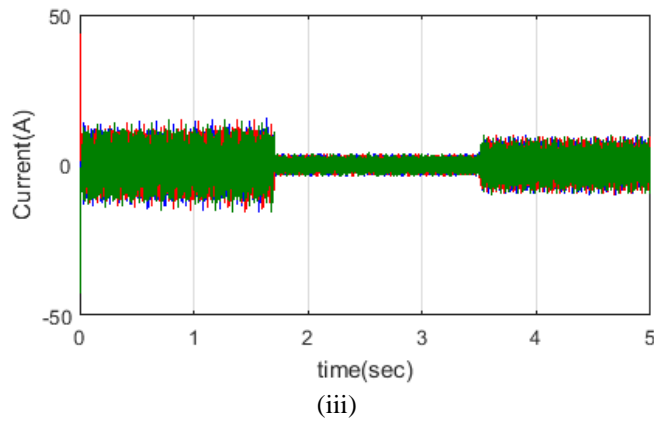

(iii)

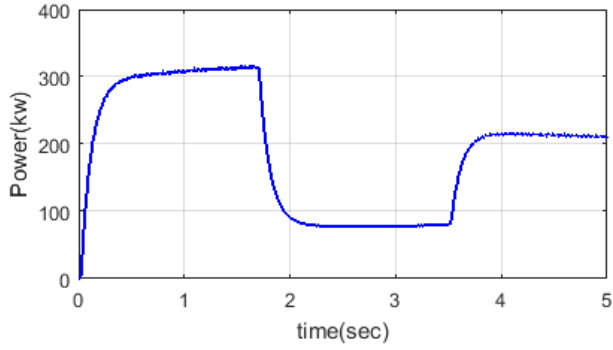

(iv)

**Figure.8** The stabilized (a) DC link voltage and output (b) voltage (c) current and (d) power grid from non-linear irradiance

In DC-link voltage, the grid voltage, current, and power are illustrated in figure 8. In this assessment, the power limitations are diverged by the irradiance. Here, the DC link voltage is generally used to control the regular level. Eventually, the presented regulator is accomplishing the advanced presentation through the distinction of dissimilar representation which is illustrated in the subsequent section.

***Comparison analysis of the proposed system***

In this section, the assessment investigation is demonstrated by the figure 9. It encompasses two conditions for output power. According to the two conditions, the output power is computed and contrasted by means of base and Jaya representation. The output power is engendered and distributed to the grid with the help of VSI. At this point, the power management is taking place at the constant location. In condition 2, the maximum power is accomplishing the complete representation.

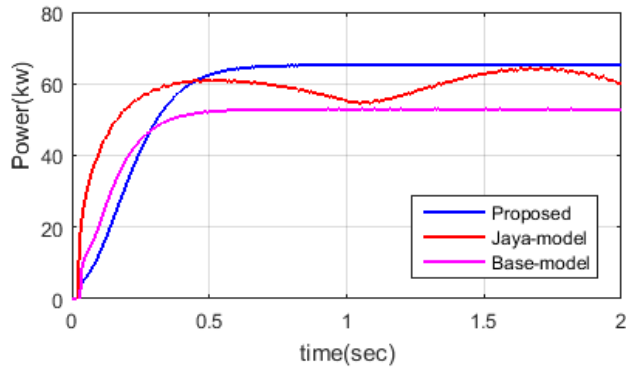

(i)

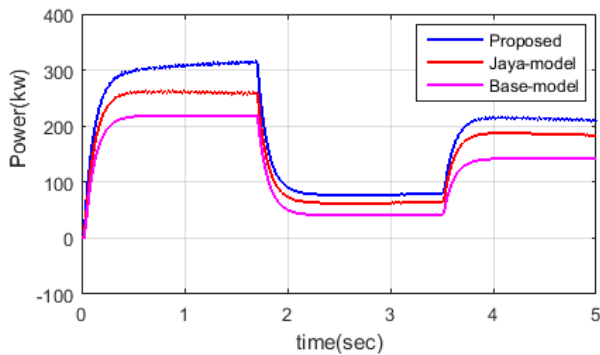

(ii)

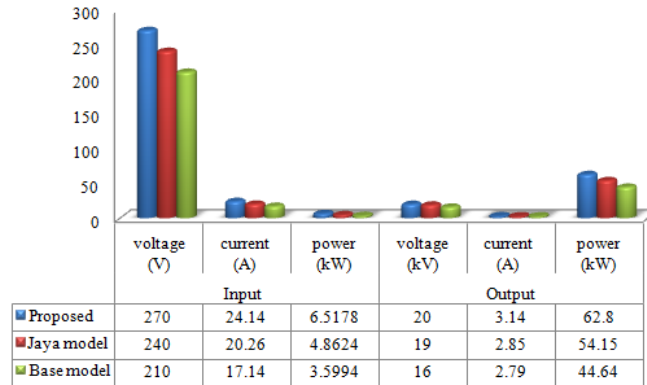

(iii)

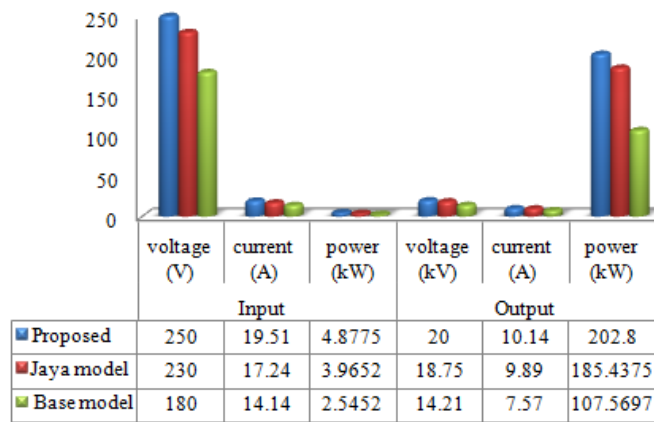

(iv)

**Figure.9** The comparative analysis of output power in (i) case 1, (ii) case 2 and the I/O power parameters in (iii) case 1, and (iv) case 2.

From these consequences, we can observe a high-quality concurrence among the consequences which is acquired with the help of two conditions. This illustrates an enhanced presentation of replication with the help of XSG which will carry out on the Matlab/Simulink structural design. Consequently, an accomplishment is turn out to be simple and very constructive.

## 5. Conclusion

Therefore, the maximum power was engendered from the PV array through the WOA related embedded regulator. The embedded control arrangement is estimated by the XSG field and grid associated PV array system which takes place in Matlab/Simulink platform. At this point, the PV array system is associated by means of the DC-DC boost converter and the VSI incorporated grid system. The presented controller is producing the switching control signal with the help of DC-DC boost converter. Eventually, the presented regulator was replicated and computed by the power limitations such as voltage, current, and power. Here, the present investigation is contrasted by way of obtainable representation to verify the efficiency of the presented regulator. After that, the presented regulator is accomplishing the efficiency through linear and non-linear irradiance conditions. Finally, the comparison analysis is verified that the presented regulator is enhanced than further representation.

## References

[1] Joel Kennedy, Phil Ciufu and Ashish Agalgaonkar, "A review of protection systems for distribution networks embedded with renewable generation", An International Journal of Renewable and Sustainable Energy Reviews, Vol.58, pp.1308–1317, 2016



- [2] A.Cagnano and E.De Tuglie, "Centralized voltage control for distribution networks with embedded PV systems", *An International Journal of Renewable Energy*, Vol.76, pp.173-185, 2015
- [3] D.Gunduz, K.Stamatiou, N.Michelusi and M.Zorzi, "Designing intelligent energy harvesting communication systems," *IEEE Transactions on Communications Magazine*, Vol.52, No.1, pp.210-216, 2014
- [4] E.Dallago, A.L.Barnabei, A.Liberale, P.Malcovati and G.Venchi, "An Interface Circuit for Low-Voltage Low-Current Energy Harvesting Systems," *IEEE Transactions on Power Electronics*, Vol.30, No.3, pp.1411-1420, 2015
- [5] Q.Liu and Q.J.Zhang, "Accuracy Improvement of Energy Prediction for Solar-Energy-Powered Embedded Systems," *IEEE Transactions on Very Large Scale Integration (VLSI) Systems*, Vol.24, No.6, pp.2062-2074, 2016
- [6] M.Maggio, H.Hoffmann, M.D.Santambrogio, A.Agarwal and A.Leva, "Power Optimization in Embedded Systems via Feedback Control of Resource Allocation," *IEEE Transactions on Control Systems Technology*, Vol.21, No.1, pp.239-246, 2013
- [7] Y.Xiang and S.Pasricha, "Run-Time Management for Multicore Embedded Systems With Energy Harvesting," *IEEE Transactions on Very Large Scale Integration (VLSI) Systems*, Vol.23, No.12, pp.2876-2889, 2015
- [8] J.T.Stauth, M.D.Seeman and K.Kesarwani, "A Resonant Switched-Capacitor IC and Embedded System for Sub-Module Photovoltaic Power Management," *IEEE Transactions on Solid-State Circuits*, Vol.47, No.12, pp.3043-3054, 2012
- [9] R.A.Shafik, S.Yang, A.Das, L.A.Maeda-Nunez, G.V.Merrett and B.M.Al-Hashimi, "Learning Transfer-Based Adaptive Energy Minimization in Embedded Systems," *IEEE Transactions on Computer-Aided Design of Integrated Circuits and Systems*, Vol.35, No.6, pp.877-890, 2016
- [10] A.Safari and S.Mekhilef, "Simulation and Hardware Implementation of Incremental Conductance MPPT with Direct Control Method Using Cuk Converter," *IEEE Transactions on Industrial Electronics*, Vol.58, No.4, pp.1154-1161, 2011
- [11] Yousra Shaiek, Mouna Ben Smida, Anis Sakly and Mohamed Faouzi Mimouni, "Comparison between conventional methods and GA approach for maximum power point tracking of shaded solar PV generators", *An International Journal of Solar Energy*, Vol.90, pp.107-122, 2013
- [12] A.Messai, A.Mellit, A.Guessoum and S.A.Kalogirou, "Maximum power point tracking using a GA optimized fuzzy logic controller and its FPGA implementation", *An International Journal of Solar Energy*, Vol.85, pp.265-277, 2011
- [13] U.Zimmermann and M.Edoff, "A Maximum Power Point Tracker for Long-Term Logging of PV Module Performance," *IEEE Transactions on Photo voltaics*, Vol.2, No.1, pp.47-55, 2012
- [14] P.Mazumdar, P.N.Enjeti and R.S.Balog, "Analysis and Design of Smart PV Modules," *IEEE Transactions on Emerging and Selected Topics in Power Electronics*, Vol.2, No.3, pp.451-459, 2014
- [15] Salim Abouda, Frederic Nollet, Najib Essounbouli, Abdessattar Chaari and Yassine Koubaa, "Design, Simulation and Voltage Control of Standalone Photovoltaic System Based MPPT: Application to a Pumping system", *An International Journal of Renewable Energy Research*, Vol.3, No.3, pp.538-549, 2013
- [16] M.A.Elgedy, B.Zahawi and D.J.Atkinson, "Assessment of Perturb and Observe MPPT Algorithm Implementation Techniques for PV Pumping Applications," *IEEE Transactions on Sustainable Energy*, Vol.3, No.1, pp.21-33, 2012
- [17] K.Ishaque, Z.Salam, M.Amjad and S.Mekhilef, "An Improved Particle Swarm Optimization (PSO)-Based MPPT for PV with Reduced Steady-State Oscillation," *IEEE Transactions on Power Electronics*, Vol.27, No.8, pp.3627-3638, 2012

- [18] M.Killi and S.Samanta, "Modified Perturb and Observe MPPT Algorithm for Drift Avoidance in Photovoltaic Systems," *IEEE Transactions on Industrial Electronics*, Vol.62, No.9, pp.5549-5559, 2015
- [19] Enrico Bianconi, Javier Calvente, Roberto Giral, Emilio Mamarelis, Giovanni Petrone, Carlos Andres Ramos-Paja, Giovanni Spagnuolo and Massimo Vitelli, "A Fast Current-Based MPPT Technique Employing Sliding Mode Control," *IEEE Transactions on Industrial Electronics*, Vol.60, No.3, pp.1168-1178, 2013
- [20] H.Renaudineau, F.Donatantonio, J.Fontchastagner, G.Petrone, G.Spagnuolo, J.P.Martin and S.Pierfederici, "A PSO-Based Global MPPT Technique for Distributed PV Power Generation," *IEEE Transactions on Industrial Electronics*, Vol.62, No.2, pp.1047-1058, 2015
- [21] A.A.Elbaset, H.Ali, M.Abd-El Sattar and M.Khaled, "Implementation of a modified perturb and observe maximum power point tracking algorithm for photovoltaic system using an embedded microcontroller," *IET Transactions on Renewable Power Generation*, Vol.10, No.4, pp.551-560, 2016
- [22] Hesham H.Gad, Amira Y.Haikal and Hesham Arafat Ali, "New design of the PV panel control system using FPGA-based MPSoC", *An International Journal of Solar Energy*, No.146, pp.243–256, 2017
- [23] Hamza Gharsellaoui, Jihen Maazoun, Nadia Bouassida, Samir Ben Ahmed and Hanene Ben-Abdallah, "A Software Product Line Design Based Approach for Real-time Scheduling of Reconfigurable Embedded Systems", *An International Journal of Computers in Human Behavior*, 2017
- [24] Ruoli Tang, Zhou Wu and Yanjun Fang, "Configuration of marine photovoltaic system and its MPPT using model predictive control", *An International Journal of Solar Energy*, Vol.158, pp.995–1005, 2017
- [25] Shaowu Li, Honghua Liao, Hailing Yuan, Qing Ai and Kunyi Chen, "A MPPT strategy with variable weather parameters through analyzing the effect of the DC/DC converter to the MPP of PV system", *An International Journal of Solar Energy*, Vol.144, pp.175–184, 2017
- [26] Ayman Youssef, Mohammed El Telbany and Abdelhalim Zekry, "Reconfigurable generic FPGA implementation of fuzzy logic controller for MPPT of PV systems", *An International Journal of Renewable and Sustainable Energy Reviews*, Vol.82, pp.1313–1319, 2018
- [27] Ling-Ling Li, Guo-Qian Lin, Ming-Lang Tseng, Kimhua Tan and Ming K.Lim, "A maximum power point tracking method for PV system with improved gravitational search algorithm", *An International Journal of Applied Soft Computing*, Vol.65, pp.333–348, 2018
- [28] Ahmed I.M.Ali, Mahmoud A.Sayed and Essam E.M.Mohamed, "Modified efficient perturb and observe maximum power point tracking technique for grid-tied PV system", *An International Journal of Electrical Power and Energy Systems*, Vol.99, pp.192–202, 2018
- [29] Zhongqiang Wu and Danqi Yu, "Application of improved bat algorithm for solar PV maximum power point tracking under partially shaded condition", *An International Journal of Applied Soft Computing*, Vol.62, pp.101-109, 2018
- [30] Rezki Tadrist, Adnane Hassani, Mountassar Maamoun and Ali Nesba, "Efficient FPGA Implementation to Estimate the Maximum Output Power of a Photovoltaic Panel Using Xilinx System Generator", *American Journal of Applied Sciences*, Vol.13, No.5, pp.522-532, 2016
- [31] R.Selvamuthukumar and R.Gupta, "Rapid prototyping of power electronics converters for photovoltaic system application using Xilinx System Generator," *IET transaction on Power Electronics*, Vol.7, No.9, pp.2269-2278, 2014
- [32] B.S.Borowy and Z.M.Salameh, "Methodology for optimally sizing the combination of a battery bank and PV array in a wind/PV hybrid system," *IEEE Transactions on Energy Conversion*, Vol.11, No.2, pp.367-375, 1996

- [33] A.D.Jones and P.Underwood, "A modelling method for building-integrated photovoltaic power supply", An International Journal of Building Services Engineering Research and Technology, Vol.23, No.3, pp.167-177, 2002
- [34] Neha Mishra, Anurag Singh Yadav, Rupendra Pachauri, Yogesh K.Chauhan and Vinod K.Yadav, "Performance enhancement of PV system using proposed array topologies under various shadow patterns", An International Journal of Solar Energy, Vol.157, pp.641–656, 2017
- [35] Seyedali Mirjalili and Andrew Lewis, "The Whale Optimization Algorithm", An International Journal of Advances in Engineering Software, Vol.95, pp.51–67, 2016
- [36] Hany M.Hasanien, "Performance improvement of photovoltaic power systems using an optimal control strategy based on whale optimization algorithm", An International Journal of Electric Power Systems Research, Vol.157, pp.168–176, 2018